



GAZCO

Gas and Electric Stoves



A Warm Welcome

Nothing creates an inviting atmosphere quite like a Gazco stove. The centrepiece of any home, it will add warmth and character to any room or living space – even if you don't have a chimney! Whether you want to achieve a minimalist, contemporary look, or have your heart set on a more traditional stove, this brochure will help you make the perfect choice, whatever your interior tastes.

From the highly efficient contemporary Gas Loft range with all its style and elegance, to the stunning cast iron detail on our traditional Chesterfield stoves, these innovative designs will appeal to any modern or traditional home.

There is also a range of highly realistic, electric log-effect stoves featuring Gazco's Chromalight® technology. These electric versions open up new possibilities such as conservatories, kitchens, dining rooms and bedrooms for you to have the warmth and character of a Gazco stove in your home.





Homebuilding
& Renovating
AWARDS
2021

WINNER
Heating & Plumbing
Supplier of the Year

★★★★★

Contents

The Gazco Pedigree 04
Expert Retailer Network 05

Traditional Stoves 06 - 07

Chesterfield 5 08 - 11
Sheraton 5 12 - 15
Marlborough2 16 - 19
Stockton 20 - 25
Huntingdon 26 - 33

Contemporary Styles 34 - 35

Loft 36 - 43
Vogue Midi & Midi T 44 - 53
Vision 54 - 61
CL 3, 5 & 8 62 - 69
Liberty 85 70 - 73
Studio Freestanding Gas 74 - 77
Stove Benches 78 - 79

Home & Flue Requirements 80 - 81
Remote Controls 82
Additional Information 83
Technical Information 84 - 96
Balanced Flue Systems 97
Other Stoves and Fires 98

Cover Images

Left: Chesterfield 5 Gas.

Right: Loft Gas with Steel Log Store.



The Gazco Pedigree...

Our gas and electric stoves are innovatively designed, solidly built and meticulously tested to ensure they continue to heat your home for many years to come.

Innovation in Design

With creativity and innovation at the heart of what we do, our expert design team continues to create unique, industry leading stoves that both inspire and endure. From the moment the first concept is sketched, through to the mapping of airflow using cutting-edge software, stove design is a science we have been perfecting since 1988.

We continually invest in our research and development facilities to ensure our team is at the forefront of fire design. Our pioneering concepts and technologies make our gas and electric models some of the most sought after stoves available.

Quality Construction

Built with the finest quality materials, each stove is engineered here in the UK. Cast iron and heavy gauge steel are used across our ranges to ensure each stove is built to the highest tolerances. Cast iron allows for the casting of intricate designs, making it perfect for traditional stoves. Heavy gauge steel is also an outstanding choice for stove construction, offering greater scope for design thanks to its versatile nature.

Rigorously Tested

Gazco is an ISO9001 and ISO14001 accredited company. Our rigorous quality control system ensures that all our appliances are safety checked and that they comply with the appropriate regulations, with all stoves in this brochure bearing both the UKCA and CE mark. Similarly, our environmental management systems ensure we work in a sustainable manner, whilst endeavouring to protect the environment by minimising any possible impact from our operations. We are recognised for our continued commitment to technical innovation, high quality products and excellent customer and after-sales care.



Expert Retailer Network

We take great care to ensure that our stoves are designed, tested and manufactured to the highest possible quality and safety standards. We are just as concerned to make certain that they are sold and installed correctly so that you enjoy years of pleasure from your purchase.

Accordingly, you will find our products are only available from experienced, independent retailers who will be happy to show you a selection of models locally in their showrooms, often fully operational. These independent retailers will discuss your individual requirements both technical (such as sizing the heat output to your room and advising on your flue type) and design, and ensure that you select the most appropriate product for your home. These retailers will also be able to advise on, or assist with, the installation process as well as help provide any after-sales support and servicing your appliance may require in the future.

Whilst we encourage our retailers to promote fireplace products and their outlets via the internet, we do not believe suitable levels of customer care and satisfaction can be obtained from purchasing the product only online and we would strongly recommend that you consider this when undertaking your research and making a purchasing decision. Furthermore, please be aware that we do not offer technical support (beyond our statutory responsibilities) to products bought via nationwide online sales, where this support would normally be offered by one of our qualified, independent retailers.

Furthermore, Gazco fires and stoves purchased from within our Expert Retailer Network will have the additional benefit of a greatly extended warranty period, subject to terms and conditions. Full details can be found at www.gazco.com.

You can find and support your nearest retailer by visiting: www.gazco.com/retailers



Warranty

Your Gazco Expert Retailer will provide you with a Two Year Warranty for your new gas or electric stove. The warranty for gas stoves can be extended to a period of five years by registering your stove with Gazco. Please note, these warranties exclude certain consumable parts. Stoves purchased outside of Gazco's Expert Retailer Network will carry a standard One Year non-extendable Warranty. Full warranty terms and conditions are available to view at www.gazco.com.



WIN the cost of your product back!

by registering your product online for your free extended warranty. See page 83 for details.



Go to the World



Traditional Stoves

Our traditional stoves combine classic casting details with modern combustion technology. Timelessly styled, they add elegance and character to period and contemporary interiors alike.

Chesterfield 5	08 - 11
Sheraton 5	12 - 15
Marlborough2	16 - 19
Stockton	20 - 25
Huntingdon	26 - 33

Chesterfield 5 Gas

Tasteful detailing and an elegant Rose Scroll door handle harmonise with clean lines, sweeping curves and an exceptional flame view.



	Heat Output & Efficiency			Chimney or Flue Options			Fuel Bed	Lining	Control
	kW HEAT OUTPUT RANGE	E% EFFICIENCY	E EFFICIENCY CLASS	BRICK CHIMNEY	PRE-FABRICATED	BALANCED FLUE	LOGS	ECHOFLAME BLACK GLASS	FULLY-SEQUENTIAL THERMOSTATIC REMOTE
Conventional Flue	1.60 - 4.00kW	76%	D	✓	✓	✗	✓	✓	✓ Page 82
Balanced Flue	1.80 - 4.00kW	90.6%	B	✗	✗	✓	✓	✓	✓ Page 82

Optional Linerless Flue Kit

This option eliminates the need for the chimney to be fully lined and any associated labour, facilitating a simpler and more cost-effective installation. For more information see page 80.

See page 10 for electric model



Efficiency figures given are based upon the maximum heat output achieved for these models. For additional information, specifications and complete model choices, please see pages 84 onwards.

SEE IT BURNING AT:
gazco.com/chesterfieldgas





SEE IT BURNING AT:

[gazco.com/chesterfieldelectric](https://www.gazco.com/chesterfieldelectric)



Chesterfield 5 Electric

Our signature Chromalight technology projects captivating flame visuals to appear between the highly realistic log effects, whilst illuminating the fuel bed from above and below.



Chesterfield 5 Electric with Log & Pebble fuel effect and Amber flame setting

	Heat Output	Interchangeable Fuel Beds		Lighting Effects			Control
	kW HEAT OUTPUT RANGE	LOG AND PEBBLE	CRYSTAL ICE EFFECT	CHROMALIGHT IMMERSIVE LED SYSTEM	MULTIPLE FLAME EFFECTS	13 FUEL BED LIGHTING COLOURS	PROGRAMMABLE THERMOSTATIC ECO REMOTE
Chesterfield 5 Electric	0.75 - 1.50kW or flame effect only	✓	✓	✓	✓	✓	✓ Page 82

See page 8 for gas models

For additional information, specifications and complete model choices, please see pages 84 onwards.

Sheraton 5 Gas

Beautifully made, this timeless stove features cast iron bevelling and corning to the door, top plate and base, for aesthetics you can appreciate even when it's off!



Sheraton 5 Gas

	Heat Output & Efficiency			Chimney or Flue Options			Fuel Bed	Lining	Control
	kW HEAT OUTPUT RANGE	E% EFFICIENCY	E EFFICIENCY CLASS	BRICK CHIMNEY	PRE-FABRICATED	BALANCED FLUE	LOGS	ECHOFLAME BLACK GLASS	FULLY-SEQUENTIAL THERMOSTATIC REMOTE
Conventional Flue	1.60 - 4.00kW	76%	D	✓	✓	✗	✓	✓	✓ Page 82
Balanced Flue	1.80 - 4.00kW	90.6%	B	✗	✗	✓	✓	✓	✓ Page 82

Efficiency figures given are based upon the maximum heat output achieved for these models. For additional information, specifications and complete model choices, please see pages 84 onwards.

Optional Linerless Flue Kit

This option eliminates the need for the chimney to be fully lined and any associated labour, facilitating a simpler and more cost effective solution. For more information see page 80.

See page 14 for electric model

See page 4 for additional image



SEE IT BURNING AT:
gazco.com/sheratongas



SEE IT BURNING AT:
[gazco.com/sheratonelectric](https://www.gazco.com/sheratonelectric)





*Sheraton 5 Electric with Log & Pebble fuel effect
and Amber flame setting*

Sheraton 5 Electric

With its mesmerising display, the Sheraton 5 electric lets you mix and match fuel effects to create a bespoke focal point to rival the allure of a real woodburner.



Sheraton 5 Electric with Log & Pebble fuel effect and Amber flame setting with Grafton Limestone mantel

	Heat Output	Interchangeable Fuel Beds		Lighting Effects			Control
	 HEAT OUTPUT RANGE	 LOG AND PEBBLE	 CRYSTAL ICE EFFECT	 CHROMALIGHT IMMERSIVE LED SYSTEM	 MULTIPLE FLAME EFFECTS	 13 FUEL BED LIGHTING COLOURS	 PROGRAMMABLE THERMOSTATIC ECO REMOTE
Sheraton 5 Electric 	0.75 - 1.50kW or flame effect only	✓	✓	✓	✓	✓	✓ Page 82

 See page 12 for gas models

For additional information, specifications and complete model choices, please see pages 84 onwards.



SEE IT BURNING AT:

gazco.com/marlborough2gas



Marlborough2 Gas

Country or city, traditional or contemporary, the innovative Gas Marlborough2 has the flexibility to suit your lifestyle and your décor. With their expansive viewing windows, enjoy the dancing flames and warm ambience from the comfort of your sofa.



Small Gas Marlborough2 conventional flue

		Heat Output & Efficiency			Chimney or Flue Options			Fuel Bed	Lining	Control Options (Page 82)		
		kW HEAT OUTPUT RANGE	E% EFFICIENCY	EFFICIENCY CLASS	BRICK CHIMNEY	PRE-FABRICATED	BALANCED FLUE	LOGS	VERMICULITE	MANUAL	STANDARD UPGRADEABLE REMOTE	PROG. THERMOSTATIC UPGRADEABLE REMOTE
Small - Conventional Flue		1.20 - 2.30kW	76%	E	✓	✓	✗	✓	✓	✓	✓	✓
Small - Balanced Flue		1.20 - 2.50kW	85.1%	C*	✗	✗	✓	✓	✓	✓	✓	✓
Medium - Conventional Flue		1.80 - 4.80kW	78%	E	✓	✓	✗	✓	✓	✓	✓	✓
Medium - Balanced Flue		2.70 - 5.50kW	90.8%	B*	✗	✗	✓	✓	✓	✓	✓	✓



See page 18 for electric models

Efficiency figures given are based upon the maximum heat output achieved for these models. For additional information, specifications and complete model choices, please see pages 84 onwards. * When using Programmable Thermostatic Remote

Marlborough2 Electric

Featuring the same distinctive styling as the gas versions, the Marlborough2 electric offers an amazingly realistic flame effect with or without heat – all at the touch of a button.



Marlborough2 Small Electric with Log & Pebble fuel effect and Amber flame setting



Marlborough2 Medium Electric with Log & Pebble fuel effect and Amber flame setting

	Heat Output	Interchangeable Fuel Beds		Lighting Effects			Control
	kW HEAT OUTPUT RANGE	 LOG AND PEBBLE	 CRYSTAL ICE EFFECT	 CHROMALIGHT IMMERSIVE LED SYSTEM	 MULTIPLE FLAME EFFECTS	 13 FUEL BED LIGHTING COLOURS	 PROGRAMMABLE THERMOSTATIC ECO REMOTE
Marlborough2 Electric Small & Medium	1.00 - 2.00kW or flame effect only	✓	✓	✓	✓	✓	✓ Page 82

See page 16 for gas models

For additional information, specifications and complete model choices, please see pages 84 onwards.

SEE IT BURNING AT:
gazco.com/marlborough2electric





SEE IT BURNING AT:
gazco.com/stockton2gas



Stockton2 Gas















Using cast iron for the door and heavy gauge steel for the body, Gas Stockton2 stoves combine simple, understated lines with Gazco's superb living flame technology. See page 22 for Stockton 5 model.



Medium Gas Stockton2 conventional flue



Small Gas Stockton2 balanced flue

		Heat Output & Efficiency			Chimney or Flue Options			Fuel Bed	Lining	Control Options (Page 82)		
												
	HEAT OUTPUT RANGE	EFFICIENCY	EFFICIENCY CLASS	BRICK CHIMNEY	PRE-FABRICATED	BALANCED FLUE	LOGS	VERMICULITE	MANUAL	STANDARD UPGRADEABLE REMOTE	PROG. THERMOSTATIC UPGRADEABLE REMOTE	
Small - Conventional Flue	 1.20 - 2.30kW	76%	E	✓	✓	✗	✓	✓	✓	✓	✓	
Small - Balanced Flue	 1.20 - 2.50kW	85.1%	C*	✗	✗	✓	✓	✓	✓	✓	✓	
Medium - Conventional Flue	 1.80 - 4.80kW	78%	E	✓	✓	✗	✓	✓	✓	✓	✓	
Medium - Balanced Flue	 2.70 - 5.50kW	90.8%	B*	✗	✗	✓	✓	✓	✓	✓	✓	



See page 24 for electric models

Efficiency figures given are based upon the maximum heat output achieved for these models. For additional information, specifications and complete model choices, please see pages 84 onwards.

* When using Programmable Thermostatic Remote



Stockton 5 Gas

With authentic woodburning stove styling, right down to the hinged door with handle, the Gas Stockton 5 is conveniently sized between the small and medium models featured on the previous page.



Gas Stockton 5 balanced flue with log-effect



Gas Stockton 5+ conventional flue with coal-effect

	Heat Output & Efficiency			Chimney or Flue Options			Fuel Bed		Lining	Control Options (Page 82)		
	HEAT OUTPUT RANGE	EFFICIENCY	EFFICIENCY CLASS	BRICK CHIMNEY	PRE-FABRICATED	BALANCED FLUE	LOGS	COALS	POLISHED STAINLESS STEEL	MANUAL	STANDARD UPGRADEABLE REMOTE	PROG. THERMOSTATIC UPGRADEABLE REMOTE
Conventional Flue	1.40 - 3.00kW	73%	E	✓	✓	✗	✗	✓	✓	✓	✓	✓
Balanced Flue	2.20 - 3.50kW	91.8%	B*	✗	✗	✓	✓	✗	✓	✓	✓	✓



See page 24 for electric models

Efficiency figures given are based upon the maximum heat output achieved for these models. For additional information, specifications and complete model choices, please see pages 84 onwards.

† Please note this is a viable installation in stone, but not suitable for combustible materials.

* When using Programmable Thermostatic Remote

See page 86 for additional image

Stockton Electric

The Stockton Electric range suits both the modern and traditional home, with classic good looks and a striking three-dimensional flame effect for increased realism.



Stockton2 Medium Electric with Log & Pebble fuel effect and Amber flame setting



Stockton2 Small Electric with Log & Pebble fuel effect and Amber flame setting

	Heat Output	Interchangeable Fuel Beds		Lighting Effects			Control
	kW HEAT OUTPUT RANGE	LOG AND PEBBLE	CRYSTAL ICE EFFECT	CHROMALIGHT IMMERSIVE LED SYSTEM	MULTIPLE FLAME EFFECTS	13 FUEL BED LIGHTING COLOURS	PROGRAMMABLE THERMOSTATIC ECO REMOTE
Stockton Electric (Small, 5 and Medium)	1.00 - 2.00kW or flame effect only	✓	✓	✓	✓	✓	✓ Page 82

See pages 20-23 for gas models

For additional information, specifications and complete model choices, please see pages 84 onwards.

SEE IT BURNING AT:
gazco.com/stocktonelectric



Stockton 5 Electric with Log & Pebble fuel effect and Amber flame setting 25



SEE IT BURNING AT:
gazco.com/huntingdon20gas



Huntingdon 20 Gas

Presented in three finishes, the compact Gas Huntingdon 20's proportions make it perfect for British fireplace openings, whilst the choice of a clear or tracery door further expands the styling options.



	Heat Output & Efficiency			Chimney or Flue Options			Fuel Bed	Lining	Styling Options		Control Options (Page 82)		
	kW HEAT OUTPUT RANGE	E% EFFICIENCY	E EFFICIENCY CLASS	BRICK CHIMNEY	PRE-FABRICATED	BALANCED FLUE	LOGS	VERMICULITE	CLEAR & TRACERY DOOR	MATT BLACK, IVORY ENAMEL & MATT IVORY FINISHES	MANUAL	STANDARD UPGRADEABLE REMOTE	PROG. THERMOSTATIC UPGRADEABLE REMOTE
Conventional Flue	1.20 - 2.30kW	76%	E	✓	✓	✗	✓	✓	✓	✓	✓	✓	✓
Balanced Flue	1.20 - 2.50kW	85.1%	C*	✗	✗	✓	✓	✓	✓	✓	✓	✓	✓

Efficiency figures given are based upon the maximum heat output achieved for these models. For additional information, specifications and complete model choices, please see pages 84 onwards.

* When using Programmable Thermostatic Remote



See page 32 for electric models



SEE IT BURNING AT:

gazco.com/huntingdon30gas

Gas Huntingdon 30 with Tracery Door in Matt Black



Huntingdon 30 Gas

The Gas Huntingdon 30 offers elegant Gothic styling, and with its beautiful flame picture, provides ample warmth and style to any interior.



Gas Huntingdon 30 with Tracery Door in Matt Black



Gas Huntingdon 30 with Clear Door in Ivory Enamel

	Heat Output & Efficiency			Chimney or Flue Options			Fuel Bed	Lining	Styling Options		Control Options (Page 82)		
	kW HEAT OUTPUT RANGE	E% EFFICIENCY	E EFFICIENCY CLASS	BRICK CHIMNEY	PRE-FABRICATED	BALANCED FLUE	LOGS	VERMICULITE	CLEAR & TRACERY DOOR	MATT BLACK, IVORY ENAMEL & MATT IVORY FINISHES	MANUAL	STANDARD UPGRADEABLE REMOTE	PROG. THERMOSTATIC UPGRADEABLE REMOTE
Conventional Flue	1.50 - 3.10kW	75%	E	✓	✓	✗	✓	✓	✓	✓	✓	✓	✓
Balanced Flue	2.10 - 3.80kW	95.4%	A*	✗	✗	✓	✓	✓	✓	✓	✓	✓	✓

Efficiency figures given are based upon the maximum heat output achieved for these models. For additional information, specifications and complete model choices, please see pages 84 onwards.

* When using Programmable Thermostatic Remote

See page 32 for electric models

See rear cover for additional image



SEE IT BURNING AT:
[gazco.com/huntingdon40gas](https://www.gazco.com/huntingdon40gas)



Huntingdon 40 Gas

The largest model in the Huntingdon range, the Gas Huntingdon 40 is perfectly at home in big open fireplaces or spacious interiors.



Gas Huntingdon 40 with Tracery Door in Matt Black



Gas Huntingdon 40 with Tracery Door in Matt Ivory.
Shown with Sandringham Limestone Mantel

	Heat Output & Efficiency			Chimney or Flue Options			Fuel Bed	Lining	Styling Options		Control Options (Page 82)		
	kW HEAT OUTPUT RANGE	E% EFFICIENCY	E EFFICIENCY CLASS	BRICK CHIMNEY	PRE-FABRICATED	BALANCED FLUE	LOGS	VERMICULITE	CLEAR & TRACERY DOOR	MATT BLACK, IVORY ENAMEL & MATT IVORY FINISHES	MANUAL	STANDARD UPGRADEABLE REMOTE	PROG. THERMOSTATIC UPGRADEABLE REMOTE
Conventional Flue	1.80 - 4.80kW	78%	E	✓	✓	✗	✓	✓	✓	✓	✓	✓	✓
Balanced Flue	2.70 - 5.50kW	90.8%	B*	✗	✗	✓	✓	✓	✓	✓	✓	✓	✓

Efficiency figures given are based upon the maximum heat output achieved for these models. For additional information, specifications and complete model choices, please see pages 84 onwards.

* When using Programmable Thermostatic Remote

See page 32 for electric models

See page 6 for additional image

Huntingdon Electric

Available in three finishes, the fine castings of the Huntingdon Electric range are brought to life with Gazco's Chromalight® Immersive LED System, offering all the fireside ambience of real flames.



Huntingdon 30 Electric with Tracery Door in Matt Ivory with Log & Pebble fuel effect and Amber flame setting



Huntingdon 20 Electric with Tracery Door in Matt Black with Log & Pebble fuel effect and Amber flame setting

	Heat Output	Interchangeable Fuel Beds		Lighting Effects			Styling Options		Control
	kW HEAT OUTPUT RANGE	LOG AND PEBBLE	CRYSTAL ICE EFFECT	CHROMALIGHT IMMERSIVE LED SYSTEM	MULTIPLE FLAME EFFECTS	13 FUEL BED LIGHTING COLOURS	CLEAR & TRACERY DOOR	MATT BLACK, IVORY ENAMEL & MATT IVORY FINISHES	PROGRAMMABLE THERMOSTATIC ECO REMOTE
Huntingdon Electric (20, 30 & 40)	1.00 - 2.00kW or flame effect only	✓	✓	✓	✓	✓	✓	✓	✓ Page 82

For additional information, specifications and complete model choices, please see pages 84 onwards.

See pages 26-31 for gas models

SEE IT BURNING AT:
[gazco.com/huntingdonelectric](https://www.gazco.com/huntingdonelectric)



Huntingdon 40 Electric with Clear Door in Matt Black with Log & Pebble fuel effect and Amber flame setting. Shown with Claremont Limestone Mantel.





Contemporary Stoves

Our contemporary stove collection presents captivating designs with elegant, minimalist styling. Adding a signature piece to any setting these designer stoves feature expansive viewing windows for an uninterrupted view of the flames.

Loft	36 - 43
Vogue	44 - 53
Vision	54 - 61
CL	62 - 69
Liberty 85	70 - 73
Studio Freestanding	74 - 77

Loft | Gas Stove Range

Clear-cut lines and sleek surfaces ensure the Loft's pure design creates a striking focal point in your interior. Reflective black glass frames the stove's tall firebox, subtly contrasting with the matt steel body. Soaring flames dance amongst a highly realistic fuel bed, composed of hand painted logs which are mirrored on all sides by the EchoFlame™ Black glass lining.



Luxurious Styling Possibilities

Loft stoves can be styled with a variety of accessories. Choose from cleanly styled Plinth and Logstore bases, with either option offered in matching steel, as well as smart Castillo grey sandstone or luxurious Woodgrain sandstone.

There is also a wall mounted version, for an ultra-modern floating installation that lends itself perfectly to contemporary settings. Regardless of the mounting options selected, the stove's height can be accentuated with a striking matching steel top section, hiding the flue pipe and continuing the stove's clean lines.



CONTEMPORARY STOVES



Loft
Loft with Steel Plinth
Loft with Steel Log Store Base
Loft with Steel Log Store Base and Top Section
Loft with Optional Wall Mounting Bracket
Loft with Optional Wall Mounting Bracket and Top Section

	kW HEAT OUTPUT RANGE	E% EFFICIENCY	EFFICIENCY CLASS	BRICK CHIMNEY	PRE-FABRICATED	BALANCED FLUE	WALL MOUNTING OPTION
Conventional Flue	2.00 - 4.40kW	78%	D	✓	✓	✗	✗
Balanced Flue	2.40 - 4.50kW	94.3%	A	✗	✗	✓	✓

Optional Linerless Flue Kit

The Loft is also compatible with our optional linerless flue kit. This eliminates the need for the chimney to be fully lined and any associated labour, facilitating a simpler and more cost effective solution. For information see page 80.

SEE IT BURNING AT:
gazco.com/loft

Loft Gas Steel Styling Options

The Loft can be tailored to your home with a host of styling options including Plinth and Logstore bases in matching matt black steel. A tall hood can also be added to accentuate the stove's height.



Loft with Steel Plinth



	Heat Output & Efficiency			Chimney or Flue Options			Fuel Bed	Lining	Control	Styling Options				
	kW HEAT OUTPUT RANGE	E% EFFICIENCY	E EFFICIENCY CLASS	BRICK CHIMNEY	PRE-FABRICATED	BALANCED FLUE	LOGS	ECHOFLAME BLACK GLASS	PROGRAMMABLE THERMOSTATIC REMOTE	STEEL PLINTH & LOG STORE BASE	STEEL TOP SECTION	SANDSTONE PLINTH & LOG STORE BASE	WALL MOUNTING OPTION	STOVE BENCH OPTION
Conventional Flue	2.00 - 4.40kW	78%	D	✓	✓	✗	✓	✓	✓ Page 82	✓ Page 38	✓ Page 37	✓ Page 44	✗	✓ Page 78
Balanced Flue	2.40 - 4.50kW	94.3%	A	✗	✗	✓	✓	✓	✓ Page 82	✓ Page 38	✓ Page 37	✓ Page 44	✓ Page 46	✓ Page 78

Efficiency figures given are based upon the maximum heat output achieved for these models. For additional information, specifications and complete model choices, please see pages 84 onwards.

See pages 5, 34, 79 for additional images

SEE IT BURNING AT:
gazco.com/loft





SEE IT BURNING AT:
[gazco.com/loft](https://www.gazco.com/loft)



Loft Gas Stone Base Options

The Loft's Plinth and Midline base options are also available in a choice of Castillo or Woodgrain sandstone. Each stone Plinth and Midline base is cut from natural sandstone for a beautifully unique appearance.

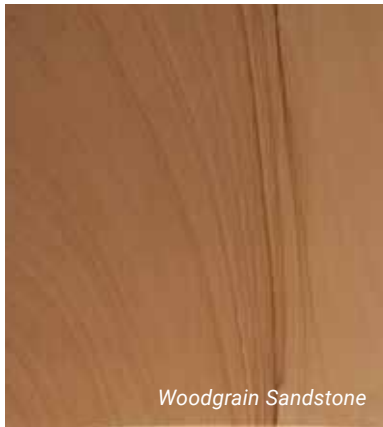

	Heat Output & Efficiency			Chimney or Flue Options			Fuel Bed	Lining	Control	Styling Options				
	kW HEAT OUTPUT RANGE	E% EFFICIENCY	E EFFICIENCY CLASS	BRICK CHIMNEY	PRE-FABRICATED	BALANCED FLUE	LOGS	ECHOFLAME BLACK GLASS	PROGRAMMABLE THERMOSTATIC REMOTE	STEEL PLINTH & LOG STORE BASE	STEEL TOP SECTION	SANDSTONE PLINTH & LOG STORE BASE	WALL MOUNTING OPTION	STOVE BENCH OPTION
Conventional Flue	2.00 - 4.40kW	78%	D	✓	✓	✗	✓	✓	✓ Page 82	✓ Page 38	✓ Page 37	✓ Page 44	✗	✓ Page 78
Balanced Flue	2.40 - 4.50kW	94.3%	A	✗	✗	✓	✓	✓	✓ Page 82	✓ Page 38	✓ Page 37	✓ Page 44	✓ Page 46	✓ Page 78

Efficiency figures given are based upon the maximum heat output achieved for these models. For additional information, specifications and complete model choices, please see pages 84 onwards.

See page 81 for additional image

Loft Gas Wall Mounted

The balanced flue Loft can be mounted on the wall to achieve an alternative, 'floating' installation, which can be styled with the matching top section if desired. Top or rear flue options offer further installation versatility.



Loft with optional Wall Mounting Bracket

		Heat Output & Efficiency			Chimney or Flue Options			Fuel Bed	Lining	Control	Styling Options			
		kW HEAT OUTPUT RANGE	E% EFFICIENCY	A EFFICIENCY CLASS	BRICK CHIMNEY	PRE-FABRICATED	BALANCED FLUE	LOGS	ECHOFLAME BLACK GLASS	PROGRAMMABLE THERMOSTATIC REMOTE	STEEL PLINTH & LOG STORE BASE	STEEL TOP SECTION	SANDSTONE PLINTH & LOG STORE BASE	WALL MOUNTING OPTION
Balanced Flue		2.40 - 4.50kW	94.3%	A	x	x	✓	✓	✓	✓ Page 82	✓ Page 38	✓ Page 37	✓ Page 44	✓ Page 46

Efficiency figures given are based upon the maximum heat output achieved for these models. For additional information, specifications and complete model choices, please see pages 84 onwards.



Vogue Midi Gas

Classic-meets-contemporary, the elegant Vogue Midi lends itself to all interior styles with its bevelled edges and refined curves. For increased presence, Midline models offer a woodstore base to complement the woodburning aesthetic.



Gas Vogue Midi Midline

	Heat Output & Efficiency			Chimney or Flue Options			Fuel Bed	Lining	Control Options (Page 82)			Styling	Optional Linerless Flue Kit
	kW HEAT OUTPUT RANGE	E% EFFICIENCY	EFFICIENCY CLASS	BRICK CHIMNEY	PRE-FABRICATED	BALANCED FLUE	LOGS	ECHOFLAME BLACK GLASS	MANUAL	STANDARD UPGRADEABLE REMOTE	PROG. THERMOSTATIC UPGRADEABLE REMOTE	STOVE BENCH OPTION	
Conventional Flue	1.60 - 4.30kW	76%	E	✓	✓	✗	✓	✓	✓	✓	✓	✓ Page 78	<p><i>This option eliminates the need for the chimney to be fully lined and any associated labour, facilitating a simpler, more cost effective solution. For more details see page 80.</i></p>
Balanced Flue	1.80 - 4.00kW	90.6%	B*	✗	✗	✓	✓	✓	✓	✓	✓	✓ Page 78	

Efficiency figures given are based upon the maximum heat output achieved for these models. For additional information, specifications and complete model choices, please see pages 84 onwards.

* When using Programmable Thermostatic Remote

See page 50 for electric models

SEE IT BURNING AT:
gazco.com/voguemidigas





SEE IT BURNING AT:
gazco.com/voguemitgas



Vogue Midi T Gas

Taking the elegant styling of the smaller Midi range, the Midi T's bevelled cast iron exterior encases a taller firebox that offers a three-sided view of the impressive visuals. This contemporary stove is also available in Midline and Highline versions, which feature stylish log store bases to add to the wood fire aesthetic.



Gas Vogue Midi T



Gas Vogue Midi T Highline **

	Heat Output & Efficiency	Chimney or Flue Options	Fuel Bed	Lining	Control Options (Page 82)	Styling Options	Optional Linerless Flue Kit							
	HEAT OUTPUT RANGE	EFFICIENCY	EFFICIENCY CLASS	BRICK CHIMNEY	PRE-FABRICATED	BALANCED FLUE	LOGS	ECHOFLAME BLACK GLASS	MANUAL	STANDARD UPGRADEABLE REMOTE	PROGRAMMABLE THERMOSTATIC UPGRADEABLE REMOTE	WALL MOUNTING OPTION	STOVE BENCH OPTION	
Conventional Flue	2.00 - 4.40kW	78%	E	✓	✓	✗	✓	✓	✓	✓	✓	✗	✓ Page 78	This option eliminates the need for the chimney to be fully lined and any associated labour, facilitating a simpler, more cost effective solution. For details see page 80.
Balanced Flue	2.40 - 4.80kW	94.3%	A*	✗	✗	✓	✓	✓	✓	✓	✓	✓ Page 48	✓ Page 78	

Efficiency figures given are based upon the maximum heat output achieved for these models. For additional information, specifications and complete model choices, please see pages 84 onwards.

* When using Programmable Thermostatic Remote ** Highline versions available as Balanced Flue models only, and whilst stocks last.

See page 52 for electric models

Vogue Midi T Gas Wall Mounted

For an alternative installation the Midi T Wall Mounted makes for a strikingly contemporary statement. This floating installation can be either rear or top flued depending on your preferences.



Gas Vogue Midi T Wall Mounted



Gas Vogue Midi T Wall Mounted

	Heat Output & Efficiency			Chimney or Flue Options			Fuel Bed	Lining	Control Options (Page 82)			Styling Options
	kW HEAT OUTPUT RANGE	E% EFFICIENCY	A* EFFICIENCY CLASS	 BRICK CHIMNEY	 PRE-FABRICATED	 BALANCED FLUE	 LOGS	 ECHOFLAME BLACK GLASS	 MANUAL	 STANDARD UPGRADEABLE REMOTE	 PROG. THERMOSTATIC UPGRADEABLE REMOTE	 WALL MOUNTING OPTION
Balanced Flue	2.40 - 4.80kW	94.3%	A*	X	X	✓	✓	✓	✓	✓	✓	✓ Page 48



See page 52 for electric models

Efficiency figures given are based upon the maximum heat output achieved for these models. For additional information, specifications and complete model choices, please see pages 82 onwards.

* When using Programmable Thermostatic Remote





SEE IT BURNING AT:

gazco.com/vogueelectric



Vogue Midi Electric

Available in two models including the Midline log store version, the Vogue Midi offers a choice of fuel beds as standard including logs, pebbles & crystal-effects, letting you mix and match to create a truly bespoke display.



Crystal Ice-effect



Vogue Midi Electric with Log & Pebble fuel effects and Amber flame setting

	Heat Output	Interchangeable Fuel Beds		Lighting Effects			Control	Styling
	kW HEAT OUTPUT RANGE	LOG AND PEBBLE	CRYSTAL ICE EFFECT	CHROMALIGHT IMMERSIVE LED SYSTEM	MULTIPLE FLAME EFFECTS	13 FUEL BED LIGHTING COLOURS	PROGRAMMABLE THERMOSTATIC ECO REMOTE	STOVE BENCH OPTION
Vogue Midi Electric	0.75 - 1.50kW or flame effect only	✓	✓	✓	✓	✓	✓ Page 82	✓ Page 78

For additional information, specifications and complete model choices, please see pages 84 onwards.

See page 82 for additional image



See page 44 for gas models

Vogue Midi T Electric

A collection of tall contemporary stoves. Each featuring windows on either side of the stylish stove body to supplement the large front window ensuring the display is visible from almost any angle.



Vogue Midi T Electric with Log & Pebble fuel effects and Amber and Blue accent flame setting.



Vogue Midi T Midline Electric with Log & Pebble Fuel effects and Amber flame setting.



Vogue Midi T Wall Hung Electric with Log & Pebble fuel effects and Amber and Blue accent flame setting.

	Heat Output	Interchangeable Fuel Beds		Lighting Effects			Control	Styling Options	
	kW HEAT OUTPUT RANGE	 LOG AND PEBBLE	 CRYSTAL ICE EFFECT	 CHROMALIGHT IMMERSIVE LED SYSTEM	 MULTIPLE FLAME EFFECTS	 13 FUEL BED LIGHTING COLOURS	 PROGRAMMABLE THERMOSTATIC ECO REMOTE	 WALL MOUNTING OPTION	 STOVE BENCH OPTION
Vogue Midi T Electric	0.75 - 1.50kW or flame effect only	✓	✓	✓	✓	✓	✓ Page 82	✓	✓ Page 78

For additional information, specifications and complete model choices, please see pages 84 onwards.
* Highline versions are available whilst stocks last.

See rear cover for additional image

See page 46-49 for gas models

SEE IT BURNING AT:
[gazco.com/voguemiditelectric](https://www.gazco.com/voguemiditelectric)



Vogue Midi T Highline Electric with Log & Pebble
Fuel effects and Amber flame setting *



SEE IT BURNING AT:
gazco.com/visionsmallgas



Vision Small Gas

The Gas Vision Small offers beautiful, contemporary aesthetics in a neat package – well suited to standard chimney openings thanks to its compact proportions.



Gas Vision Small on 100 Low Bench

	Heat Output & Efficiency			Chimney or Flue Options			Fuel Bed	Lining	Control Options (Page 82)			Styling
	HEAT OUTPUT RANGE	EFFICIENCY	EFFICIENCY CLASS	BRICK CHIMNEY	PRE-FABRICATED	BALANCED FLUE	LOGS	VERMICULITE	MANUAL	STANDARD UPGRADEABLE REMOTE	PROG. THERMOSTATIC UPGRADEABLE REMOTE	STOVE BENCH OPTION
Conventional Flue	1.20 - 2.30kW	76%	E	✓	✓	✗	✓	✓	✓	✓	✓	✓ Page 78
Balanced Flue	1.20 - 2.50kW	85.1%	C*	✗	✗	✓	✓	✓	✓	✓	✓	✓ Page 78



See page 60 for electric models

Efficiency figures given are based upon the maximum heat output achieved for these models. For additional information, specifications and complete model choices, please see pages 84 onwards.

* When using Programmable Thermostatic Remote



SEE IT BURNING AT:
gazco.com/visionmidigas



Vision Midi Gas

With its pure lines and stylish black glass surfaces, the Gas Vision Midi brings the age old concept of the stove into the present day, offering wood fire ambience with clean, modern styling.



Gas Vision Midi

	Heat Output & Efficiency			Chimney or Flue Options			Fuel Bed	Lining	Control Options (Page 82)			Styling
	HEAT OUTPUT RANGE	EFFICIENCY	EFFICIENCY CLASS	BRICK CHIMNEY	PRE-FABRICATED	BALANCED FLUE	LOGS	VERMICULITE	MANUAL	STANDARD UPGRADEABLE REMOTE	PROG. THERMOSTATIC UPGRADEABLE REMOTE	STOVE BENCH OPTION
Conventional Flue	1.50 - 3.10kW	75%	E	✓	✓	✗	✓	✓	✓	✓	✓	✓ Page 78
Balanced Flue	2.10 - 3.80kW	95.4%	A*	✗	✗	✓	✓	✓	✓	✓	✓	✓ Page 78

Efficiency figures given are based upon the maximum heat output achieved for these models. For additional information, specifications and complete model choices, please see pages 84 onwards.

* When using Programmable Thermostatic Remote



See page 60 for electric models

See page 78 for additional image

Vision Medium Gas

The Gas Vision Medium is the largest model in the Vision range with a powerful heat output to match, making it a great choice for installing into expansive inglenook fireplaces or bigger rooms.



	Heat Output & Efficiency			Chimney or Flue Options			Fuel Bed	Lining	Control Options (Page 82)			Styling
	kW HEAT OUTPUT RANGE	E% EFFICIENCY	E EFFICIENCY CLASS	BRICK CHIMNEY	PRE-FABRICATED	BALANCED FLUE	LOGS	VERMICULITE	MANUAL	STANDARD UPGRADEABLE REMOTE	PROG. THERMOSTATIC UPGRADEABLE REMOTE	STOVE BENCH OPTION
Conventional Flue	1.80 - 4.80kW	78%	E	✓	✓	✗	✓	✓	✓	✓	✓	✓ Page 78
Balanced Flue	2.70 - 5.50kW	90.8%	B*	✗	✗	✓	✓	✓	✓	✓	✓	✓ Page 78

Efficiency figures given are based upon the maximum heat output achieved for these models. For additional information, specifications and complete model choices, please see pages 84 onwards.

* When using Programmable Thermostatic Remote



See page 78 for electric models

SEE IT BURNING AT:
gazco.com/visionmediumgas



SEE IT BURNING AT:
gazco.com/visionelectric



Vision Electric

The Vision is a contemporary, electric, with each size sporting a highly reflective black glass door, integral glass plinth, black glass top plate and stainless steel detailing for a clean stylish look.



	Heat Output	Interchangeable Fuel Beds		Lighting Effects			Control	Styling
	kW HEAT OUTPUT RANGE	LOG AND PEBBLE	CRYSTAL ICE EFFECT	CHROMALIGHT IMMERSIVE LED SYSTEM	MULTIPLE FLAME EFFECTS	13 FUEL BED LIGHTING COLOURS	PROGRAMMABLE THERMOSTATIC ECO REMOTE	STOVE BENCH OPTION
Vision Electric Small, Midi & Medium	1.00 - 2.00kW or flame effect only	✓	✓	✓	✓	✓	✓	✓ Page 78

For additional information, specifications and complete model choices, please see pages 84 onwards.

See page 54-59 for gas models



SEE IT BURNING AT:
gazco.com/cl3gas



CL3 Gas

The compact CL3 brings charm to any interior and is perfect for smaller rooms or narrow inglenooks – or anywhere you need to add a little heat and ambience.



CL3 Gas

	Heat Output & Efficiency			Chimney or Flue Options			Fuel Bed	Lining	Control Options (Page 82)			Styling
	HEAT OUTPUT RANGE	EFFICIENCY	EFFICIENCY CLASS	BRICK CHIMNEY	PRE-FABRICATED	BALANCED FLUE	LOGS	VERMICULITE	MANUAL	STANDARD UPGRADEABLE REMOTE	PROG. THERMOSTATIC UPGRADEABLE REMOTE	STOVE BENCH OPTION
Conventional Flue	1.20 - 2.30kW	76.0%	E	✓	✓	✗	✓	✓	✓	✓	✓	✓ Page 78
Balanced Flue	1.20 - 2.50kW	85.1%	C*	✗	✗	✓	✓	✓	✓	✓	✓	✓ Page 78



See page 68 for electric models

Efficiency figures given are based upon the maximum heat output achieved for these models. For additional information, specifications and complete model choices, please see pages 84 onwards.

* When using Programmable Thermostatic Remote

CL5 Gas

Effortlessly bridging the gap between modern and traditional stove design, CL5 gas stoves balance simplicity with subtle details.

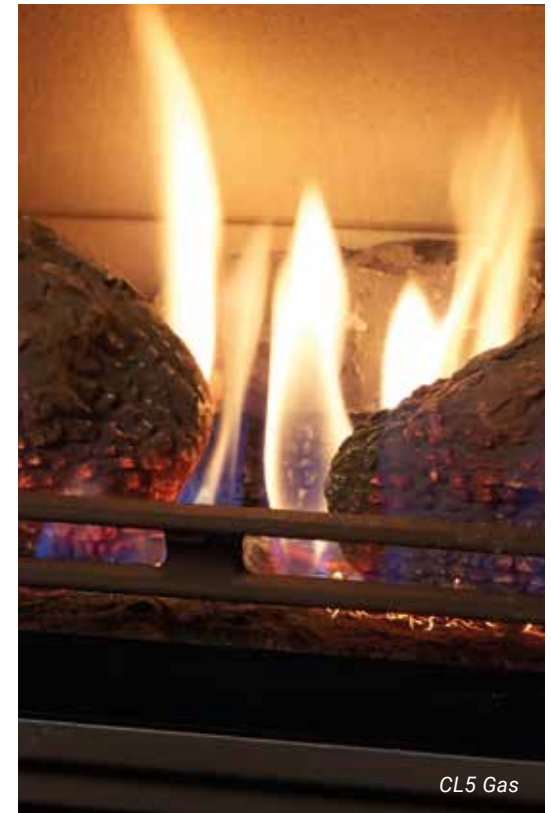

	Heat Output & Efficiency			Chimney or Flue Options			Fuel Bed	Lining	Control Options (Page 82)			Styling
	HEAT OUTPUT RANGE	EFFICIENCY	EFFICIENCY CLASS	BRICK CHIMNEY	PRE-FABRICATED	BALANCED FLUE	LOGS	VERMICULITE	MANUAL	STANDARD UPGRADEABLE REMOTE	PROG. THERMOSTATIC UPGRADEABLE REMOTE	STOVE BENCH OPTION
Conventional Flue	1.50 - 3.10kW	75.0%	E	✓	✓	✗	✓	✓	✓	✓	✓	✓ Page 78
Balanced Flue	2.10 - 3.80kW	95.4%	A*	✗	✗	✓	✓	✓	✓	✓	✓	✓ Page 78



See page 68 for electric models

Efficiency figures given are based upon the maximum heat output achieved for these models. For additional information, specifications and complete model choices, please see pages 84 onwards.

* When using Programmable Thermostatic Remote

SEE IT BURNING AT:
gazco.com/cl5gas



CL8 Gas

The largest model in the range, the CL8 Gas makes for an impressive centrepiece with a heat output to match. An expansive glass viewing window ensures an excellent view of the flames.



CL8 on 100 Low Bench

	Heat Output & Efficiency			Chimney or Flue Options			Fuel Bed	Lining	Control Options (Page 82)			Styling
	HEAT OUTPUT RANGE	EFFICIENCY	EFFICIENCY CLASS	BRICK CHIMNEY	PRE-FABRICATED	BALANCED FLUE	LOGS	VERMICULITE	MANUAL	STANDARD UPGRADEABLE REMOTE	PROG. THERMOSTATIC UPGRADEABLE REMOTE	STOVE BENCH OPTION
Conventional Flue	1.80 - 4.80kW	78.0%	E	✓	✓	✗	✓	✓	✓	✓	✓	✓ Page 78
Balanced Flue	2.70 - 5.50kW	90.8%	B*	✗	✗	✓	✓	✓	✓	✓	✓	✓ Page 78



See page 68 for electric models

Efficiency figures given are based upon the maximum heat output achieved for these models. For additional information, specifications and complete model choices, please see pages 84 onwards.

* When using Programmable Thermostatic Remote



SEE IT BURNING AT:
gazco.com/cl8gas



SEE IT BURNING AT:
[gazco.com/clelectric](https://www.gazco.com/clelectric)



CL Electric

CL electric stoves come in three sizes each featuring our remote controlled Chromalight LED lighting systems for extraordinarily realistic visuals, with an assortment of fuel effects to choose from.



CL3 Electric with Log & Pebble fuel effect and Amber flame setting, on 45 Low Bench



CL8 Electric with Log & Pebble fuel effect and Amber flame setting

	Heat Output	Interchangeable Fuel Beds		Lighting Effects			Control	Styling
	kW HEAT OUTPUT RANGE	 LOG AND PEBBLE	 CRYSTAL ICE EFFECT	 CHROMALIGHT IMMERSIVE LED SYSTEM	 MULTIPLE FLAME EFFECTS	 13 FUEL BED LIGHTING COLOURS	 PROGRAMMABLE THERMOSTATIC ECO REMOTE	 STOVE BENCH OPTION
CL3	1.00 - 2.00kW or flame effect only	✓	✓	✓	✓	✓	✓ Page 78	

For additional information, specifications and complete model choices, please see pages 84 onwards.

See page 62 for additional image

See page 62-67 for gas models

Liberty 85 Electric

Designed to make a statement, the Liberty 85 Electric stove combines bold design language, advanced technologies, and a range of customisable options. See overleaf for more installation choices.



Liberty 85 Electric in Black with matching Black Bench, with Log & Pebble fuel effect and Amber flame setting

	Heat Output	Interchangeable Fuel Beds		Lighting Effects			Control	Styling Options		
	kW HEAT OUTPUT RANGE	LOG AND PEBBLE	CRYSTAL ICE EFFECT	CHROMALIGHT IMMERSIVE LED SYSTEM	MULTIPLE FLAME EFFECTS	13 FUEL BED LIGHTING COLOURS	PROGRAMMABLE THERMOSTATIC ECO REMOTE	WHITE OR BLACK FINISH	PLINTH OR BENCH MOUNTING OPTIONS	STOVE BENCH OPTION
Liberty 85	1.00 - 2.00kW or flame effect only	✓	✓	✓	✓	✓	✓	✓	✓	✓ Page 78

For additional information, specifications and complete model choices, please see pages 84 onwards.

See page 94 for image of Liberty 85 with Bench in White

For more options see overleaf

Liberty 85 Electric in White with matching White Plinth, with Log & Pebble fuel effect and Amber and Blue accent flame setting

SEE IT BURNING AT:
[gazco.com/liberty85](https://www.gazco.com/liberty85)





SEE IT BURNING AT:
gazco.com/liberty85



Liberty 85 Electric in Black with Log & Pebble fuel effect and Amber flame setting, on a 120 High Bench

Liberty 85 Electric (continued)

In addition to the matching Plinth and Bench options shown on the preceding pages, the Liberty 85 can also be installed on a number of our Stove Benches (shown on page 78) or without any mounting options at all.



Liberty 85 Electric in White with Log & Pebble fuel effect and Amber flame setting

	Heat Output	Interchangeable Fuel Beds		Lighting Effects			Control	Styling Options		
	HEAT OUTPUT RANGE	LOG AND PEBBLE	CRYSTAL ICE EFFECT	CHROMALIGHT IMMERSIVE LED SYSTEM	MULTIPLE FLAME EFFECTS	13 FUEL BED LIGHTING COLOURS	PROGRAMMABLE THERMOSTATIC ECO REMOTE	WHITE OR BLACK FINISH	PLINTH OR BENCH MOUNTING OPTIONS	STOVE BENCH OPTION
Liberty 85	1.00 - 2.00kW or flame effect only	✓	✓	✓	✓	✓	✓	✓	✓	✓ Page 78

For additional information, specifications and complete model choices, please see pages 84 onwards.

See page 78 for an additional image

For more options see preceding pages

Studio 1 Freestanding Gas

A designer gas stove with a range of styling options, the Studio 1 Freestanding transforms your home to offer the very best in relaxing ambience.



	Heat Output & Efficiency			Chimney or Flue Options			Fuel Bed	Lining Options			Control	Mounting
	kW HEAT OUTPUT RANGE	E% EFFICIENCY	E EFFICIENCY CLASS	BRICK CHIMNEY	PRE-FABRICATED	BALANCED FLUE	LOGS	ECHOFLAME BLACK GLASS	VERMICULITE	BLACK REEDED	PROGRAMMABLE THERMOSTATIC REMOTE	PLINTH OR BENCH MOUNTING OPTIONS
Conventional Flue	2.00 - 4.60kW	72%	E	✓	✓	✗	✓	As standard	Optional	Optional	✓ Page 82	✓
Balanced Flue	3.00 - 5.30kW	92%	A	✗	✗	✓	✓	As standard	Optional	Optional	✓ Page 82	✓

Efficiency figures given are based upon the maximum heat output achieved for these models. For additional information, specifications and complete model choices, please see pages 84 onwards.

See page 95 for additional image

SEE IT BURNING AT:
gazco.com/studio1freestandinggas



Studio 1 Freestanding conventional flue with matching Black Bench and EchoFlame Black Glass lining



SEE IT BURNING AT:
gazco.com/studio2freestandinggas



Studio 2 Freestanding balanced flue with matching
Black Bench and Black Reeded lining

Studio 2 Freestanding Gas

The landscape Studio 2 Freestanding offers an expansive view of the realistic flames and can be customised with different firebox linings, as well as a choice of either plinth or bench mounting options.



Studio 2 Freestanding conventional flue with matching Black Plinth and EchoFlame Black Glass lining

	Heat Output & Efficiency			Chimney or Flue Options			Fuel Bed	Lining Options			Control	Mounting
	kW HEAT OUTPUT RANGE	E% EFFICIENCY	EFFICIENCY CLASS	BRICK CHIMNEY	PRE-FABRICATED	BALANCED FLUE	LOGS	ECHOFLAME BLACK GLASS	VERMICULITE	BLACK REEDED	PROGRAMMABLE THERMOSTATIC REMOTE	PLINTH OR BENCH MOUNTING OPTIONS
Conventional Flue	2.70 - 6.30kW	81%	C	✓	✓	✗	✓	As standard	Optional	Optional	✓	✓
Balanced Flue	3.20 - 7.00kW	92%	A	✗	✗	✓	✓	As standard	Optional	Optional	✓	✓

See page 96 for additional image

Efficiency figures given are based upon the maximum heat output achieved for these models. For additional information, specifications and complete model choices, please see pages 84 onwards.

Stove Benches

These versatile steel benches are compatible with the Loft, Vision, Vogue and Liberty 85 stoves. With a variety of sizes they offer greater design possibilities such as central or offset stove positioning, expanding your styling options.



Product Code	Bench	W (mm)	H (mm)	D (mm)
RVACLB45BHT*	45 Low bench	450	250	420
RVACB45BHT*	45 High bench	450	350	420
RVACLB100BHT*	100 Low bench	1000	250	420
RVACB100BHT*	100 High bench	1000	350	420
RVACLB120BHT	120 Low bench	1200	250	420
RVACB120BHT	120 High bench	1200	350	420
RVACLB140BHT	140 Low bench	1400	250	420
RVACB140BHT	140 High bench	1400	350	420
RVACLB180BHT	180 Low bench	1800	250	465
RVACB180BHT	180 High bench	1800	350	465

Deeper Bench Options (500mm Deep)

RVACLB120BHT	120 Low bench (500mm deep)	1200	250	500
RVACB120BHT	120 High bench (500mm deep)	1200	350	500
RVACLB140BHT	140 Low bench (500mm deep)	1400	250	500
RVACB140BHT	140 High bench(500mm deep)	1400	350	500
RVACLB180BHT	180 Low bench (500mm deep)	1800	250	500
RVACB180BHT	180 High bench (500mm deep)	1800	350	500

*Not compatible with Liberty 85 Electric Stoves



Gas Vogue Midi T on 100 Low Bench



Gas Vision Midi on 45 Low Bench



Liberty 85 Electric in White with Log & Pebble fuel effect and Amber flame setting, on a 120 Low Deep Bench



Loft on 120 High Bench

Your Home and Flue Requirements

When selecting your stove, your local Gazco retailer will need to make sure it's suitable for your home. Firstly, you need to know what fuel type you will be using. Secondly, you will need to be aware of what type of chimney or flue you have. If you do not have a chimney then don't worry, Gazco have models developed to suit your home too!

Conventional Flue - Gas

Conventional flue systems are easily recognisable as either a conventional brick or stone chimney or pre-fabricated chimney system. Should your home have none of these at present, it is usually possible to have a pre-fabricated system installed if required.



Brick or Stone Chimney
(Class 1)

The chimney stack rises well above the roofline and is topped by a traditional chimney pot or gas terminal. This type of chimney relies on the natural circulation of heated air to expel the products of combustion up your chimney.



Pre-Fabricated Flues
(Class 1 & 2)

You will see a metal flue cowl on your roof. Some are all metal whilst others may terminate through a short rectangular pot (but without a chimney stack). These flues create the same circulation of heated air as a brick or stone chimney.

Rigid or Flexible Metal Flue Systems

With this flue system rigid metal tubes, or a combination of rigid and flexible metal tubes, extend vertically directly from the stove to the outside of the property. This may be either straight through the ceiling or roof with the flue pipe exposed, or by using the channel of a chimney or a studwork enclosure. The products of combustion are carried up the flue by natural convection.

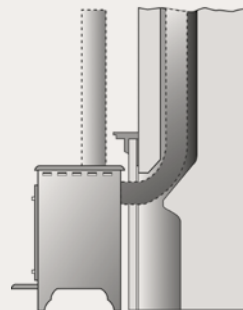

Optional Linerless Flue Kit

A selection of Gazco conventional flue gas stoves are compatible with our optional linerless flue kit. At just 0.5 metres long, this short piece of flexible, stainless steel flue pipe and debris deflector has been specifically designed to be slotted into your masonry chimney. This eliminates the need for the chimney to be fully lined and any associated labour, facilitating a simpler and more cost effective solution.

The Optional Linerless Flue Kit is compatible with:

- Chesterfield 5 Gas
- Sheraton 5 Gas
- Vogue Midi Gas Range
- Vogue Midi T Gas Range
- Loft Range

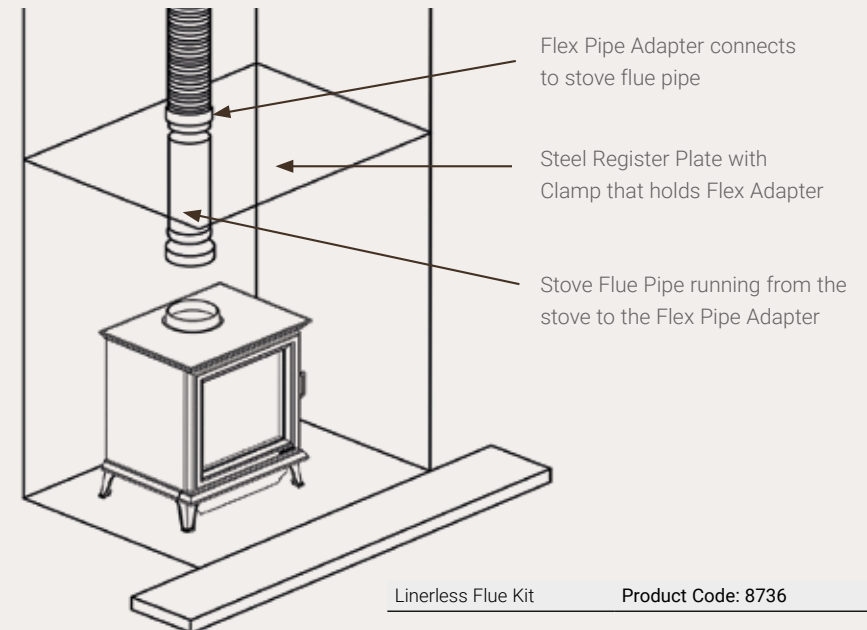

Balanced Flue - Gas

Balanced flues models are completely sealed from the room into which they are installed (so there are no draughts and heating efficiency is increased) and a twin-wall pipe vents directly to an outside wall.



Balanced Flue
(No chimney required)

Air for combustion is drawn in through the outer pipe whilst the inner pipe removes the combustion gases to the exterior of the property. Depending on the stove selected, the twin-walled pipe may exit horizontally through an external wall or vertically through the roof. Gazco offers a comprehensive range of balanced flue system components.



Balanced Flue System Options

- A - Rear outlet (max 600mm wall thickness).
- B - Top outlet/up and out (min rise 500mm, max 3m), horizontal (min 250mm, max 5m). An additional bend can be incorporated in to the horizontal section of the 'up and out', dependent upon a 1m min vertical rise.
- C - Top outlet/vertical (min 3m, max 10m). Vogue Midi T / Vogue Midi T Midline (Min 2m, Max 10m)
- D - Top outlet/vertical with offset (min to first bend 500mm, max flue length 10m).

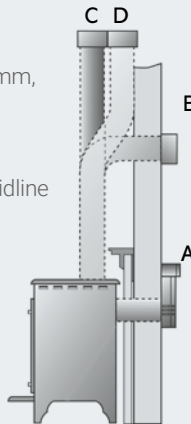

Ask your retailer for full technical details or see our Balanced Flue System brochure at www.gazco.com.

Electric Stoves

(No chimney required)

Our range of electric stoves incorporates our Chromalight Immersive LED technology and do not have any chimney or flue requirements. From the contemporary collection of Vision to the more traditional Sheraton models, these electric fires can be enjoyed with or without the heat and operated using a remote control, so you can enjoy the warmth and ambience from the comfort of your favourite chair!



No Air Vent Required (UK)

All stoves shown with this symbol, boast the advantage of not normally requiring an air vent* where the air permeability is greater than 5.0m³/hr/m². Please discuss this in full with your local Gazco retailer.



**Requirements in the Republic of Ireland are different.*

Loft with Woodgrain
Sandstone Log Store



Remote Controls

Gas Stoves

Gazco was the first UK company to introduce remote controls for gas fires. Today, our remote control systems for our gas stoves feature advanced technologies and offer the ultimate in convenience.

Standard upgradeable remote control



Once the pilot light has been ignited manually you can vary the flame height and heat output from the comfort of your armchair.

(Upgradeable option for Marlborough2, Stockton, Huntingdon, Vogue and Vision gas stoves)

Programmable Thermostatic upgradeable remote control



This deluxe version has two additional features. The first allows you to thermostatically control the room temperature whilst the second allows you to programme your stove to switch itself on and off twice a day.

(Upgradeable option for Marlborough2, Stockton, Huntingdon, Vogue and Vision gas stoves)

Programmable Thermostatic remote control *(Supplied with Loft & Studio Freestanding)*



This advanced remote is loaded with exciting features that make it possible to programme your stove to perfectly complement your lifestyle. Not only can you ignite, extinguish and thermostatically control your stove, this remote control system benefits from advanced technology that gives you the option to create an automatic, intelligent heating program that means your home is comfortable and cosy at any time of the day or night.

Fully-sequential thermostatic remote control *(Supplied with Gas Chesterfield 5 and Sheraton 5)*



Gazco's fully-sequential thermostatic control system allows you to ignite your stove in seconds as well as adjust flame height from the comfort of your sofa. You can also set your stove to be controlled thermostatically to maintain your preferred room temperature.

Electric Stoves

Our range of Electric Stoves are as easy to install as plugging in and switching on! They are available in a range of designs from traditional to modern, to suit all homes and tastes.

The Gazco Programmable Thermostatic Eco Handset



All Gazco Electric stoves features Gazco's Eco remote control, which provides complete control over the stove's Chromalight flame colours and lighting effects, as well as heating and energy saving features. Ambient heating control allows you to set the optimum temperature for your room between 15°C and 25°C, with the stove automatically managing heating power to reach the chosen temperature as efficiently as possible. Daily and weekly heating lets you program your stove to suit your lifestyle and can be easily advanced or delayed without disrupting scheduling.

Energy saving features such as Open Window Detection save energy by turning off the heat if a sudden drop in room temperature of 4°C or more is detected, for example when a door or window is opened. Heating can be easily resumed by pressing the heat button again or closing the window.



Vogue Midi Electric with Crystal-Ice fuel effect on Blue flame setting

Additional Information

Product Improvement & Brochure Photography

Gazco pursue a policy of continuous product improvement, therefore, whilst our products are correct at the time of the photography, we reserve the right to make alterations and amendments. Exact product details should be discussed with your retailer at the time of purchase.

All fire and flame photography has been taken from genuine products; however, the exact appearance of the flame picture for any appliance will vary depending on the nature of the flue type, installation surroundings, local geographical features and the way in which the appliance is operated. Owing to variations in studio lighting and printing inks, the colours of stoves illustrated in this brochure may differ slightly from actual models.

Given that building regulations are subject to constant change, some of the photography in this brochure may not comply with the requirements of the latest Building Regulations and you should always check your proposed installation arrangement with your qualified gas installer before proceeding. Certain settings in this brochure are dependent on the use of heat shields to reduce the required separation from combustible material.

Please note: The operation and appearance of gas appliances depends on variable factors such as the gas pressure supplied.

Installation and Safety

Gazco gas stoves must be fitted by a qualified gas installer (Gas Safe registered in the United Kingdom or Bord Gais registered in the Republic of Ireland) who should also verify the proposed site conditions are fully suitable for the product selected. Complete installation instructions for many models can be obtained prior to purchase by downloading them from www.gazco.com.

Please note that all parts of these stoves become extremely hot during operation and can result in serious injury and burns if touched. It is therefore recommended that a fireguard complying with BS 8423:2002 is used in the presence of young children, the elderly or infirm.

Technical Specifications

All specifications given in the main part of this brochure are approximate. Actual specifications for each individual product will vary according to the exact model and are given on pages 84 - 96. Your Gazco retailer will be pleased to help explain specific model specifications and provide any further information you may require, or you can view/download specification sheets from www.gazco.com.

Servicing and Support

To keep your gas stove looking and performing at it's best, it must be serviced annually. This service must be undertaken



by a GasSafe (Great Britain), CORGI (Northern Ireland) or Bord Gáis (Republic of Ireland) approved engineer and your retailer can organise this for you. Alternatively, Gazco offer a manufacturer's premium service with our friendly team of qualified engineers which can be booked at www.gazco.com/support.

Warranty information

Your Gazco Expert Retailer will provide you with a Two Year Warranty for your new gas or electric stove. The warranty for gas stoves can be extended to a period of Five years by registering your stove with Gazco. Please note, these warranties exclude certain consumable parts. Stoves purchased outside of Gazco's Expert Retailer Network will carry a standard One Year non-extendable Warranty. Full warranty terms and conditions are available to view at www.gazco.com.



WIN

 the cost of your product back!

For further home inspiration you can **view real life installations** at our Customer Showcase page and **share your thoughts and photos of your new stove or fire installation to enter our draw!**

- We will publish your entry on our Customer Showcase
- You will be entered into a draw for the chance to win the cost of your product back
- **Gain a second entry** by registering your product online for your free extended warranty at gazco.com/registration



View real life installations and submit your review at gazco.com/customershowcase

* Terms and conditions apply. See online for details

Technical Information

The below information is to assist in your choice of a suitable Gazco stove. This is not intended to be all the information required to install your stove. This can be obtained from your local Gazco retailer or you can download the full installation instructions at www.gazco.com

Chesterfield 5 Gas and Electric

Dimensions (mm)

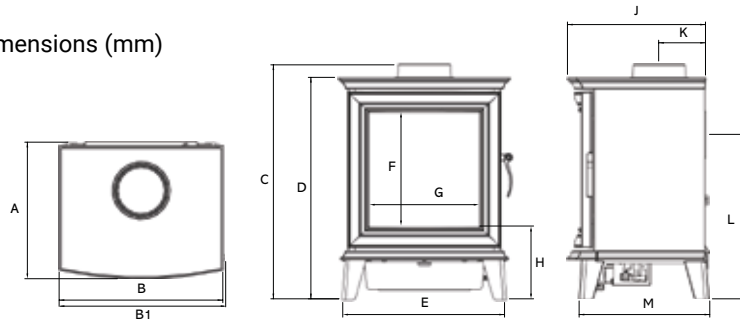

	A	B	B1	C	D	E	F	G	H	J	K	L	M	Weight
Chesterfield 5 Gas (CF)	392	472	477	650	614	450	316	304	201	383	130	456	358	62kg
Chesterfield 5 Gas (BF)	392	472	477	672	614	450	316	304	201	383	146	447	358	63kg
Chesterfield 5 Electric	391	472	477	-	614	450	316	304	201	383	-	-	358	56kg

Recommended clearances between gas stove and other surfaces: top 9" (225mm), sides 6" (150mm), rear must be a minimum of 2" (50mm).

Product Code	Colour	Flue Type	Fuel Type	Heat Input	Heat Output	Efficiency	Energy Efficiency Class
⊗ 505-003	Matt Black	Conventional	Nat.Gas	5.80kW	4.00kW	76%	D
⊗ 505-402	Matt Black	Conventional	LPG	5.40kW	3.80kW	76%	D
⊗ 505-051	Matt Black	Balanced	Nat.Gas	4.70kW	3.80kW	90.6%	B
⊗ 505-633	Matt Black	Balanced	LPG	4.80kW	4.00kW	90.6%	B
⊗ 605-850	Matt Black	-	Electric	-	1.50kW	-	-

Options for Gas Chesterfield 5

Options for Gas Chesterfield 5	Product Code
Linerless Flue Kit	8736

Stove Flue Pipe

1' Straight pipe	4500
2' Straight pipe	4501
3' Straight pipe	4502
90° long 'elbow' adaptor (9" projection)	4514

Stove Flue Pipe Balanced flue versions of the Gas Chesterfield 5 must only use the 6" stainless steel flue provided. Gazco recommends the use of 5" matt black enamelled stove pipe with the conventional flue version Chesterfield 5 stove.

Sheraton 5 Gas and Electric

Dimensions (mm)

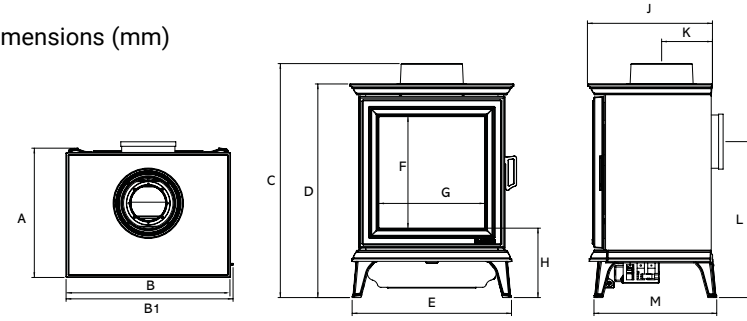

	A	B	B1	C	D	E	F	G	H	J	K	L	M	Weight
Sheraton 5 Gas (CF)	371	472	479	651	615	458	320	304	200	359	130	457	353	61kg
Sheraton 5 Gas (BF)	371	472	479	673	615	458	320	304	200	359	146	449	353	62kg
Sheraton 5 Electric	371	472	479	-	615	458	320	304	200	359	-	-	358	55kg

Recommended clearances between gas stove and other surfaces: top 9" (225mm), sides 6" (150mm), rear must be a minimum of 2" (50mm).

Product Code	Colour	Flue Type	Fuel Type	Heat Input	Heat Output	Efficiency	Energy Efficiency Class
⊗ 505-014	Matt Black	Conventional	Nat.Gas	5.80kW	4.00kW	76%	D
⊗ 505-428	Matt Black	Conventional	LPG	5.40kW	3.80kW	76%	D
⊗ 505-215	Matt Black	Balanced	Nat.Gas	4.70kW	3.80kW	90.6%	B
⊗ 505-537	Matt Black	Balanced	LPG	4.80kW	4.00kW	90.6%	B
⊗ 605-832	Matt Black	-	Electric	-	1.50kW	-	-

Options for Gas Sheraton 5

Options for Gas Sheraton 5	Product Code
Linerless Flue Kit	8736

Stove Flue Pipe

1' Straight pipe	4500
2' Straight pipe	4501
3' Straight pipe	4502
90° long 'elbow' adaptor (9" projection)	4514

Stove Flue Pipe Balanced flue versions of the Gas Sheraton 5 must only use the 6" stainless steel flue provided. Gazco recommends the use of 5" matt black enamelled stove pipe with the conventional flue version Sheraton 5 stove.

Technical Information

The below information is to assist in your choice of a suitable Gazco stove. This is not intended to be all the information required to install your stove. This can be obtained from your local Gazco retailer or you can download the full installation instructions at www.gazco.com

Marlborough2 Gas and Electric

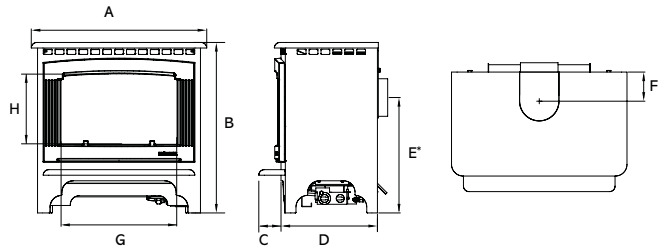

Recommended clearances between stove and other surfaces: top 9" (225mm), sides 6" (150mm), rear must be a minimum of 2" (50mm).

* Small balanced flue models are rear flue exit only

Dimensions (mm)

	A	B	C	D	E	F	G	H	Weight
Small Marlborough2 Gas (CF)	429	533	75	280	349	110	232	211	35kg
Medium Marlborough2 Gas (CF)	600	583	76	330	395	103	232	211	57kg
Small Marlborough2 Gas (BF)*	429	533	75	280	369	110	398	241	36kg
Medium Marlborough2 Gas (BF)	600	583	76	330	445	129	398	241	67kg
Small Marlborough2 Electric	429	558	75	280	-	-	232	211	33kg
Medium Marlborough2 Electric	600	583	76	330	-	-	398	241	50kg

Product Code	Model	Colour	Flue Type	Fuel Type	Heat Input	Heat Output	Efficiency	Energy Efficiency Class
⊗ 559-009	Small	Matt Black	Conventional	Nat.Gas	3.30kW	2.30kW	76%	E
⊗ 559-448	Small	Matt Black	Conventional	LPG	3.20kW	2.20kW	76%	E
⊗ 559-024	Small	Matt Black	Balanced	Nat.Gas	3.20kW	2.50kW	85.1%	C#
⊗ 559-462	Small	Matt Black	Balanced	LPG	3.10kW	2.40kW	85.1%	C#
⊗ 559-018	Medium	Matt Black	Conventional	Nat Gas	6.60kW	4.60kW	78%	E
⊗ 559-456	Medium	Matt Black	Conventional	LPG	6.70kW	4.80kW	78%	E
⊗ 559-033	Medium	Matt Black	Balanced	Nat Gas	6.60kW	5.40kW	90.8%	B#
⊗ 559-471	Medium	Matt Black	Balanced	LPG	6.60kW	5.50kW	90.8%	B#
⊗ 659-085	Small	Matt Black	-	Electric	-	2.00kW	-	-
⊗ 659-112	Medium	Matt Black	-	Electric	-	2.00kW	-	-

Gas Remote Control Options

	Product Code
Standard Upgradeable Remote Control	8455
Programmable Thermostatic Upgradeable Remote Control	8456

When upgraded with a Programmable Thermostatic Control (8456)

Stove Flue Pipe & Flue Collars

1' Straight pipe	4500
2' Straight pipe	4501
3' Straight pipe	4502
90° long 'elbow' adaptor (9" projection)	4514
Optional Top Exit Flue Collar (CF)	8549
Optional Top Exit Flue Collar (BF)	8548

Stove Flue Pipe Balanced flue versions of the Gas Marlborough2 must only use the 6" stainless steel flue provided. Gazco recommends the use of 5" matt black enamelled stove pipe with the conventional flue version Marlborough2 stove.



Marlborough2 Small Electric with Log & Pebble fuel effect and Amber flame setting

Technical Information

The below information is to assist in your choice of a suitable Gazco stove. This is not intended to be all the information required to install your stove. This can be obtained from your local Gazco retailer or you can download the full installation instructions at www.gazco.com

Stockton2 & Stockton 5 Gas and Electric

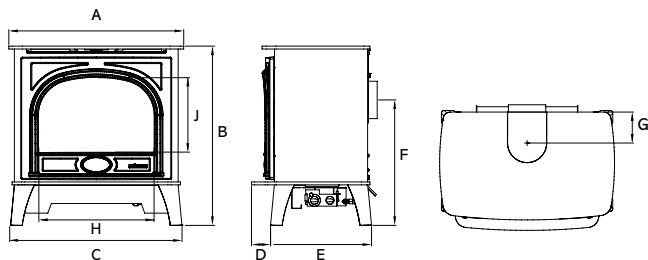

Recommended clearances between stove and other surfaces: top 9" (225mm), sides 6" (150mm), rear must be a minimum of 2" (50mm).

*Small balanced flue stoves are rear exit only.

Dimensions (mm)

	A	B	C	D	E	F	G	H	J	Weight
Small Stockton2 Gas (CF)	438	525	418	50	290	348	111	232	220	52kg
Stockton 5 Gas (CF)	481	544	-	64	273	380	92	267	212	55kg
Medium Stockton2 Gas (CF)	601	617	589	65	347	432	107	398	258	78.5kg
Small Stockton2 Gas (BF)*	438	525	418	50	290	368	111	232	220	53kg
Stockton 5 Gas (BF)	481	544	-	64	273	401	139	267	212	55kg
Medium Stockton2 Gas (BF)	601	617	589	65	347	482	136	398	258	87kg
Small Stockton2 Electric	438	525	418	50	290	-	-	232	220	50kg
Stockton 5 Electric	481	544	-	64	273	-	-	-	-	55kg
Medium Stockton2 Electric	601	617	589	65	347	-	139	398	258	72kg

Product Code	Model	Colour	Flue Type	Fuel Effect	Fuel Type	Heat Input	Heat Output	Efficiency	Energy Efficiency Class
⊗ 504-053	Small	Matt Black	Conventional	Logs	Nat Gas	3.30kW	2.30kW	76%	E
⊗ 504-513	Small	Matt Black	Conventional	Logs	LPG	3.20kW	2.20kW	76%	E
⊗ 504-078	Small	Matt Black	Balanced	Logs	Nat Gas	3.20kW	2.50kW	85.1%	C#
⊗ 504-536	Small	Matt Black	Balanced	Logs	LPG	3.10kW	2.40kW	85.1%	C#
⊗ 8575MCUC	5	Matt Black	Conventional	Coal	Nat Gas	4.60kW	3.00kW	73%	E
⊗ P8575MCUC	5	Matt Black	Conventional	Coal	LPG	4.40kW	3.00kW	73%	E
⊗ 8563LUC	5	Matt Black	Balanced	Logs	Nat Gas	4.25kW	3.50kW	91.8%	B#
⊗ P8563LUC	5	Matt Black	Balanced	Logs	LPG	4.10kW	3.50kW	84.5%	B#
⊗ 504-066	Medium	Matt Black	Conventional	Logs	Nat Gas	6.60kW	4.60kW	78%	E
⊗ 504-522	Medium	Matt Black	Conventional	Logs	LPG	6.70kW	4.80kW	78%	E
⊗ 504-085	Medium	Matt Black	Balanced	Logs	Nat Gas	6.60kW	5.40kW	90.8%	B*
⊗ 504-547	Medium	Matt Black	Balanced	Logs	LPG	6.60kW	5.50kW	90.8%	B#
⊗ 604-144	Small	Matt Black	-	Various	Electric	-	2.00kW	-	-
⊗ 604-172	5	Matt Black	-	Various	Electric	-	2.00kW	-	-
⊗ 604-203	Medium	Matt Black	-	Various	Electric	-	2.00kW	-	-

When upgraded with a Programmable Thermostatic Control (8456)



Gas Remote Control Options

	Product Code
Standard Upgradeable Remote Control	8455
Programmable Thermostatic Upgradeable Remote Control	8456

Stove Flue Pipe

1' Straight pipe	4500
2' Straight pipe	4501
3' Straight pipe	4502
90° long 'elbow' adaptor (9" projection)	4514
Optional Top Exit Flue Collar (CF)	8549
Optional Top Exit Flue Collar (BF)	8548

Stove Flue Pipe Balanced flue versions of the Gas Stockton must only use the 6" stainless steel flue provided. Gazco recommends the use of 5" Matt Black enamelled stove pipe with the conventional flue version.

Technical Information

The below information is to assist in your choice of a suitable Gazco stove. This is not intended to be all the information required to install your stove. This can be obtained from your local Gazco retailer or you can download the full installation instructions at www.gazco.com

Huntingdon 20 Gas and Electric

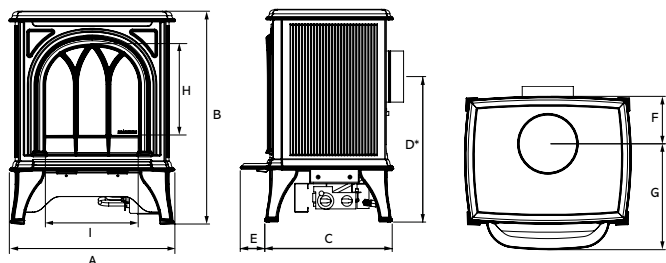

Recommended clearances between stove and other surfaces: top 9" (225mm), sides 6" (150mm), rear must be a minimum of 2" (50mm).

*Huntingdon 20 Balanced Flue is Rear Exit only.

Dimensions (mm)

	A	B	C	D	E	F	G	H	I	Weight
Huntingdon 20 Gas (CF)	416	535	320	366	62	119	266	223	234	45kg
Huntingdon 20 Gas (BF)*	416	535	320	386	62	160	225	223	234	45kg
Huntingdon 20 Electric	413	536	324	-	62	-	-	223	234	35kg

Remote Controls

Product Code

Standard Upgradeable Remote Control	8455
Programmable Thermostatic Upgradeable Remote Control	8456

Stove Flue Pipe and Collars

1' Straight pipe, Matt Black	4500
2' Straight pipe, Matt Black	4501
3' Straight pipe, Matt Black	4502
90° long 'elbow' adaptor (9" projection), Matt Black	4514
1' Straight pipe, Ivory	4500IV
2' Straight pipe, Ivory	4501IV
3' Straight pipe, Ivory	4502IV
1' Straight pipe, Matt Ivory	4500PI
2' Straight pipe, Matt Ivory	4501PI
3' Straight pipe, Matt Ivory	4502PI
Matt Black Flue collar, Conventional Flue, Huntingdon	999-010
Matt Ivory Flue collar, Conventional Flue, Huntingdon	999-266
Ivory Enamel Flue collar, Conventional Flue, Huntingdon	999-456

Stove Flue Pipe Balanced flue versions of the Gas Huntingdon 20 must only use the 6" stainless steel flue provided. For additional Matt Black, Matt Ivory and Ivory enamelled flue collars, please see the Gazco Stoves price list. Gazco recommends the use of 5" Matt Black enamelled stove pipe with the conventional flue version.

Gas & Electric Huntingdon 20 Tracery Door

Product Code	Colour	Door Style	Flue Type	Fuel Type	Heat Input	Heat Output	Efficiency	Energy Efficiency Class
⊗ 515-035	Matt Black	Tracery	Conventional	Nat Gas	3.30kW	2.30kW	76%	E
⊗ 515-405	Matt Black	Tracery	Conventional	LPG	3.20kW	2.20kW	76%	E
⊗ 515-044	Ivory	Tracery	Conventional	Nat Gas	3.30kW	2.30kW	76%	E
⊗ 515-423	Ivory	Tracery	Conventional	LPG	3.20kW	2.20kW	76%	E
⊗ 515-053	Matt Ivory	Tracery	Conventional	Nat Gas	3.30kW	2.30kW	76%	E
⊗ 515-432	Matt Ivory	Tracery	Conventional	LPG	3.20kW	2.20kW	76%	E
⊗ 515-098	Matt Black	Tracery	Balanced	Nat Gas	3.20kW	2.50kW	85.1%	C#
⊗ 515-502	Matt Black	Tracery	Balanced	LPG	3.10kW	2.40kW	85.1%	C#
⊗ 515-107	Ivory	Tracery	Balanced	Nat Gas	3.20kW	2.50kW	85.1%	C#
⊗ 515-511	Ivory	Tracery	Balanced	LPG	3.10kW	2.40kW	85.1%	C#
⊗ 515-116	Matt Ivory	Tracery	Balanced	Nat Gas	3.20kW	2.50kW	85.1%	C#
⊗ 515-520	Matt Ivory	Tracery	Balanced	LPG	3.10kW	2.40kW	85.1%	C#
⊗ 615-258	Matt Black	Tracery	-	Electric	-	2.00kW	-	-
⊗ 615-371	Ivory	Tracery	-	Electric	-	2.00kW	-	-
⊗ 615-624	Matt Ivory	Tracery	-	Electric	-	2.00kW	-	-

Gas & Electric Huntingdon 20 Clear Door

⊗ 515-071	Matt Black	Clear	Conventional	Nat Gas	3.30kW	2.30kW	76%	E
⊗ 515-441	Matt Black	Clear	Conventional	LPG	3.20kW	2.20kW	76%	E
⊗ 515-080	Ivory	Clear	Conventional	Nat Gas	3.30kW	2.30kW	76%	E
⊗ 515-468	Ivory	Clear	Conventional	LPG	3.20kW	2.20kW	76%	E
⊗ 515-089	Matt Ivory	Clear	Conventional	Nat Gas	3.30kW	2.30kW	76%	E
⊗ 515-477	Matt Ivory	Clear	Conventional	LPG	3.20kW	2.20kW	76%	E
⊗ 515-125	Matt Black	Clear	Balanced	Nat Gas	3.20kW	2.50kW	85.1%	C#
⊗ 515-529	Matt Black	Clear	Balanced	LPG	3.10kW	2.40kW	85.1%	C#
⊗ 515-134	Ivory	Clear	Balanced	Nat Gas	3.20kW	2.50kW	85.1%	C#
⊗ 515-545	Ivory	Clear	Balanced	LPG	3.10kW	2.40kW	85.1%	C#
⊗ 515-143	Matt Ivory	Clear	Balanced	Nat Gas	3.20kW	2.50kW	85.1%	C#
⊗ 515-556	Matt Ivory	Clear	Balanced	LPG	3.10kW	2.40kW	85.1%	C#
⊗ 615-011	Matt Black	Clear	-	Electric	-	2.00kW	-	-
⊗ 615-037	Ivory	Clear	-	Electric	-	2.00kW	-	-
⊗ 615-050	Matt Ivory	Clear	-	Electric	-	2.00kW	-	-

When upgraded with a Programmable Thermostatic Control (8456)

Technical Information

The below information is to assist in your choice of a suitable Gazco stove. This is not intended to be all the information required to install your stove. This can be obtained from your local Gazco retailer or you can download the full installation instructions at www.gazco.com

Huntingdon 30 Gas and Electric

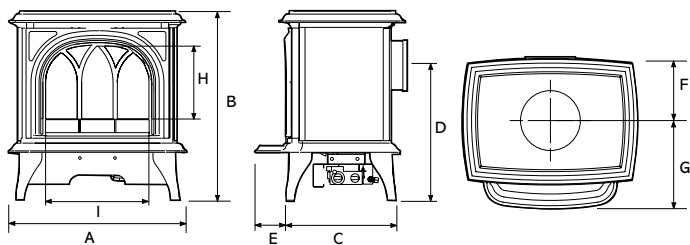

Recommended clearances between stove and other surfaces: top 9" (225mm), sides 6" (150mm), rear must be a minimum of 2" (50mm). The Huntingdon 30 has a choice of top or rear flue exit

Dimensions (mm)

	A	B	C	D	E	F	G	H	I	Weight
Huntingdon 30 Gas (CF)	560	592	351	403	96	174	304	230	323	72kg
Huntingdon 30 Gas (BF)	560	592	351	422	96	195	278	230	323	72kg
Huntingdon 30 Electric	560	592	351	-	99	-	-	230	323	52kg

Remote Controls

Product Code

Standard Upgradeable Remote Control	8455
Programmable Thermostatic Upgradeable Remote Control	8456

Stove Flue Pipe and Collars

1' Straight pipe, Matt Black	4500
2' Straight pipe, Matt Black	4501
3' Straight pipe, Matt Black	4502
90° long 'elbow' adaptor (9" projection), Matt Black	4514
1' Straight pipe, Ivory	4500IV
2' Straight pipe, Ivory	4501IV
3' Straight pipe, Ivory	4502IV
1' Straight pipe, Matt Ivory	4500PI
2' Straight pipe, Matt Ivory	4501PI
3' Straight pipe, Matt Ivory	4502PI
Matt Black Flue collar, Conventional Flue, Huntingdon	999-010
Matt Black Flue collar, Balanced Flue, Huntingdon	999-347
Ivory Enamel Flue collar, Conventional Flue, Huntingdon	999-266
Ivory Enamel Flue collar, Balanced Flue, Huntingdon	999-507
Matt Ivory Flue collar, Conventional Flue, Huntingdon	999-456
Matt Ivory Flue collar, Balanced Flue, Huntingdon	999-683

Stove Flue Pipe Balanced flue versions of the Gas Huntingdon 30 must only use the 6" stainless steel flue provided. For additional Matt Black, Matt Ivory and Ivory enamelled flue collars, please see the Gazco Stoves price list. Gazco recommends the use of 5" Matt Black enamelled stove pipe with the conventional flue version.

Gas & Electric Huntingdon 30 Tracery Door

Product Code	Colour	Door Style	Flue Type	Fuel Type	Heat Input	Heat Output	Efficiency	Energy Efficiency Class
⊗ 515-004	Matt Black	Tracery	Conventional	Nat Gas	4.55kW	3.10kW	75%	E
⊗ 515-413	Matt Black	Tracery	Conventional	LPG	4.35kW	3.00kW	75%	E
⊗ 515-154	Ivory	Tracery	Conventional	Nat Gas	4.55kW	3.10kW	75%	E
⊗ 515-484	Ivory	Tracery	Conventional	LPG	4.35kW	3.00kW	75%	E
⊗ 515-212	Matt Ivory	Tracery	Conventional	Nat Gas	4.55kW	3.10kW	75%	E
⊗ 515-536	Matt Ivory	Tracery	Conventional	LPG	4.35kW	3.00kW	75%	E
⊗ 515-257	Matt Black	Tracery	Balanced	Nat Gas	4.30kW	3.70kW	95.4%	A [#]
⊗ 515-561	Matt Black	Tracery	Balanced	LPG	4.30kW	3.80kW	95.4%	A [#]
⊗ 515-395	Ivory	Tracery	Balanced	Nat Gas	4.30kW	3.70kW	95.4%	A [#]
⊗ 515-664	Ivory	Tracery	Balanced	LPG	4.30kW	3.80kW	95.4%	A [#]
⊗ 515-333	Matt Ivory	Tracery	Balanced	Nat Gas	4.30kW	3.70kW	95.4%	A [#]
⊗ 515-712	Matt Ivory	Tracery	Balanced	LPG	4.30kW	3.80kW	95.4%	A [#]
⊗ 615-285	Matt Black	Tracery	-	Electric	-	2.00kW	-	-
⊗ 615-427	Ivory	Tracery	-	Electric	-	2.00kW	-	-
⊗ 615-643	Matt Ivory	Tracery	-	Electric	-	2.00kW	-	-

Gas & Electric Huntingdon 30 Clear Door

⊗ 515-009	Matt Black	Clear	Conventional	Nat Gas	4.55kW	3.10kW	75%	E
⊗ 515-453	Matt Black	Clear	Conventional	LPG	4.35kW	3.00kW	75%	E
⊗ 515-061	Ivory	Clear	Conventional	Nat Gas	4.55kW	3.10kW	75%	E
⊗ 515-505	Ivory	Clear	Conventional	LPG	4.35kW	3.00kW	75%	E
⊗ 515-100	Matt Ivory	Clear	Conventional	Nat Gas	4.55kW	3.10kW	75%	E
⊗ 515-570	Matt Ivory	Clear	Conventional	LPG	4.35kW	3.00kW	75%	E
⊗ 515-139	Matt Black	Clear	Balanced	Nat Gas	4.30kW	3.70kW	95.4%	A [#]
⊗ 515-726	Matt Black	Clear	Balanced	LPG	4.30kW	3.80kW	95.4%	A [#]
⊗ 515-165	Ivory	Clear	Balanced	Nat Gas	4.30kW	3.70kW	95.4%	A [#]
⊗ 515-739	Ivory	Clear	Balanced	LPG	4.30kW	3.80kW	95.4%	A [#]
⊗ 515-191	Matt Ivory	Clear	Balanced	Nat Gas	4.30kW	3.70kW	95.4%	A [#]
⊗ 515-765	Matt Ivory	Clear	Balanced	LPG	4.30kW	3.80kW	95.4%	A [#]
⊗ 615-094	Matt Black	Clear	-	Electric	-	2.00kW	-	-
⊗ 615-142	Ivory	Clear	-	Electric	-	2.00kW	-	-
⊗ 615-183	Matt Ivory	Clear	-	Electric	-	2.00kW	-	-

When upgraded with a Programmable Thermostatic Control (8456)

Technical Information

The below information is to assist in your choice of a suitable Gazco stove. This is not intended to be all the information required to install your stove. This can be obtained from your local Gazco retailer or you can download the full installation instructions at www.gazco.com

Huntingdon 40 Gas and Electric

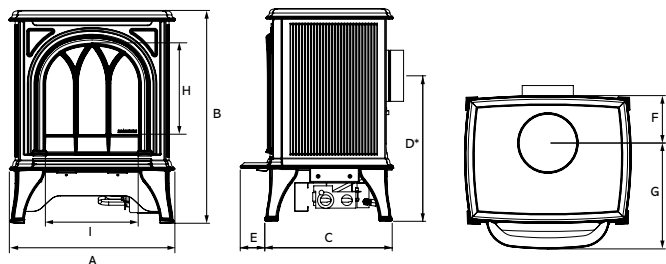

Recommended clearances between stove and other surfaces: top 9" (225mm), sides 6" (150mm), rear must be a minimum of 2" (50mm).

*Huntingdon 20 Balanced Flue is Rear Exit only.

Dimensions (mm)	A	B	C	D	E	F	G	H	I	Weight
Huntingdon 40 Gas (CF)	641	653	382	460	99	154	350	265	402	71kg
Huntingdon 40 Gas (BF)	641	653	382	510	99	183	321	265	402	75kg
Huntingdon 40 Electric	641	653	397	-	99	-	-	265	402	59.5kg

Remote Controls for Gas Huntingdon 40

Product Code

Standard Upgradeable Remote Control	8455
Programmable Thermostatic Upgradeable Remote Control	8456

Stove Flue Pipe and Collars

1' Straight pipe, Matt Black	4500
2' Straight pipe, Matt Black	4501
3' Straight pipe, Matt Black	4502
90° long 'elbow' adaptor (9" projection), Matt Black	4514
1' Straight pipe, Ivory	4500IV
2' Straight pipe, Ivory	4501IV
3' Straight pipe, Ivory	4502IV
1' Straight pipe, Matt Ivory	4500PI
2' Straight pipe, Matt Ivory	4501PI
3' Straight pipe, Matt Ivory	4502PI
Matt Black Flue collar, Conventional Flue, Huntingdon	999-010
Matt Black Flue collar, Balanced Flue, Huntingdon	999-347
Ivory Enamel Flue collar, Conventional Flue, Huntingdon	999-266
Ivory Enamel Flue collar, Balanced Flue, Huntingdon	999-507
Matt Ivory Flue collar, Conventional Flue, Huntingdon	999-456
Matt Ivory Flue collar, Balanced Flue, Huntingdon	999-683

Stove Flue Pipe Balanced flue versions of the Gas Huntingdon 40 must only use the 6" stainless steel flue provided. For additional Matt Black, Matt Ivory and Ivory enamelled flue collars, please see the Gazco Stoves price list. Gazco recommends the use of 5" Matt Black enamelled stove pipe with the conventional flue version.

Gas & Electric Huntingdon 40 Tracery Door

Product Code	Colour	Door Style	Flue Type	Fuel Type	Heat Input	Heat Output	Efficiency	Energy Efficiency Class
⊗ 515-161	Matt Black	Tracery	Conventional	Nat Gas	6.60kW	4.60kW	78%	E
⊗ 515-565	Matt Black	Tracery	Conventional	LPG	6.70kW	4.80kW	78%	E
⊗ 515-170	Ivory	Tracery	Conventional	Nat Gas	6.60kW	4.60kW	78%	E
⊗ 515-574	Ivory	Tracery	Conventional	LPG	6.70kW	4.80kW	78%	E
⊗ 515-179	Matt Ivory	Tracery	Conventional	Nat Gas	6.60kW	4.60kW	78%	E
⊗ 515-583	Matt Ivory	Tracery	Conventional	LPG	6.70kW	4.80kW	78%	E
⊗ 515-224	Matt Black	Tracery	Balanced	Nat Gas	6.60kW	5.40kW	90.8%	B#
⊗ 515-628	Matt Black	Tracery	Balanced	LPG	6.60kW	5.50kW	90.8%	B#
⊗ 515-233	Ivory	Tracery	Balanced	Nat Gas	6.60kW	5.40kW	90.8%	B#
⊗ 515-646	Ivory	Tracery	Balanced	LPG	6.60kW	5.50kW	90.8%	B#
⊗ 515-242	Matt Ivory	Tracery	Balanced	Nat Gas	6.60kW	5.40kW	90.8%	B#
⊗ 515-655	Matt Ivory	Tracery	Balanced	LPG	6.60kW	5.50kW	90.8%	B#
⊗ 615-302	Matt Black	Tracery	-	Electric	-	2.00kW	-	-
⊗ 615-613	Ivory	Tracery	-	Electric	-	2.00kW	-	-
⊗ 615-662	Matt Ivory	Tracery	-	Electric	-	2.00kW	-	-

Gas & Electric Huntingdon 40 Clear Door

⊗ 515-188	Matt Black	Clear	Conventional	Nat Gas	6.60kW	4.60kW	78%	E
⊗ 515-592	Matt Black	Clear	Conventional	LPG	6.70kW	4.80kW	78%	E
⊗ 515-197	Ivory	Clear	Conventional	Nat Gas	6.60kW	4.60kW	78%	E
⊗ 515-601	Ivory	Clear	Conventional	LPG	6.70kW	4.80kW	78%	E
⊗ 515-206	Matt Ivory	Clear	Conventional	Nat Gas	6.60kW	4.60kW	78%	E
⊗ 515-619	Matt Ivory	Clear	Conventional	LPG	6.70kW	4.80kW	78%	E
⊗ 515-251	Matt Black	Clear	Balanced	Nat Gas	6.60kW	5.40kW	90.8%	B#
⊗ 515-673	Matt Black	Clear	Balanced	LPG	6.60kW	5.50kW	90.8%	B#
⊗ 515-269	Ivory	Clear	Balanced	Nat Gas	6.60kW	5.40kW	90.8%	B#
⊗ 515-682	Ivory	Clear	Balanced	LPG	6.60kW	5.50kW	90.8%	B#
⊗ 515-278	Matt Ivory	Clear	Balanced	Nat Gas	6.60kW	5.40kW	90.8%	B#
⊗ 515-691	Matt Ivory	Clear	Balanced	LPG	6.60kW	5.50kW	90.8%	B#
⊗ 615-123	Matt Black	Clear	-	Electric	-	2.00kW	-	-
⊗ 615-157	Ivory	Clear	-	Electric	-	2.00kW	-	-
⊗ 615-222	Matt Ivory	Clear	-	Electric	-	2.00kW	-	-

When upgraded with a Programmable Thermostatic Control (8456)

Technical Information

The below information is to assist in your choice of a suitable Gazco stove. This is not intended to be all the information required to install your stove. This can be obtained from your local Gazco retailer or you can download the full installation instructions at www.gazco.com

Vogue Gas and Electric

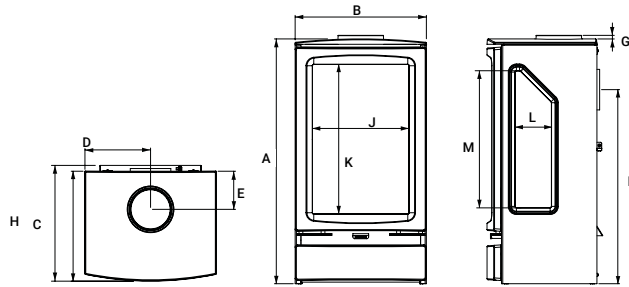

Recommended clearances between stove and other surfaces: top 225mm, sides 150mm rear must be a minimum of 50mm.

The complete range of Gas Vogue stoves have a choice of top or rear flue exit.

Stove Benches Vogue stoves can also be placed on one of our stove benches. Please see page 78 for further information.

Vogue Midi Gas & Electric Dimensions (mm)

	A	B	C	D	E	F	G	H	J	K	L	M	Weight
Vogue Gas Midi (CF)	639	416	348	208	121	478	11	-	306	337	-	-	42kg
Vogue Gas Midi (BF)	639	416	348	208	137	470	11	-	306	337	-	-	40kg
Vogue Gas Midi Midline (CF)	791	416	348	208	121	630	11	-	306	337	-	-	47kg
Vogue Gas Midi Midline (BF)	791	416	348	208	137	622	11	-	306	337	-	-	47kg
Vogue Electric Midi	639	416	348	-	-	-	-	-	306	337	-	-	42kg
Vogue Electric Midi Midline	791	416	348	-	-	-	-	-	306	337	-	-	48kg

Vogue Midi T Gas & Electric Dimensions (mm)

	A	B	C	D	E	F	G	H	J	K	L	M	Weight
Vogue Gas Midi T (CF)	776	416	348	208	121	615	11	367	306	475	115	434	54kg
Vogue Gas Midi T (BF)	776	416	348	209	137	607	11	-	306	475	115	434	55kg
Vogue Gas Midi T Midline (CF)	928	416	348	208	121	767	11	367	306	475	115	434	61kg
Vogue Gas Midi T Midline (BF)	928	416	348	209	137	759	11	-	306	475	115	434	62kg
Vogue Gas Midi T Highline (BF)**	1260	416	348	209	137	1091	11	-	306	475	115	434	83kg
Vogue Gas Midi T Wall Mounted (BF)	776	416	348*	209	137	-	11	-	306	475	115	434	62kg
Vogue Electric Midi T	776	418	349	-	-	-	-	-	306	475	115	434	38kg
Vogue Electric Midi T Midline	928	418	349	-	-	-	-	-	306	475	115	434	44kg
Vogue Electric Midi T Highline**	1260	418	349	-	-	-	-	-	306	475	115	434	65kg
Vogue Electric Midi T Wall Mounted	776	416	348*	-	-	-	-	-	306	475	115	434	44kg

*360mm Depth when fitted with wall bracket

Options for Gas Vogue

	Product Code
Standard Upgradeable Remote Control	8455
Programmable Thermostatic Upgradeable Remote Control	8456
Vogue Midi T Highline (BF) Rear Vanity Cover Kit	963-175
Linerless Flue Kit	8736

Vogue Midi Gas & Electric

Product Code	Model	Flue Type	Fuel Type	Heat Input	Heat Output	Efficiency	Energy Efficiency Class
563-123	Midi	Conventional	Nat.Gas	6.20kW	4.20kW	76%	E
563-426	Midi	Conventional	LPG	6.20kW	4.30kW	76%	E
563-016	Midi	Balanced	Nat.Gas	4.80kW	3.90kW	90.6%	B#
563-400	Midi	Balanced	LPG	4.80kW	4.00kW	90.6%	B#
563-392	Midi Midline	Conventional	Nat.Gas	6.20kW	4.20kW	76%	E
563-466	Midi Midline	Conventional	LPG	6.20kW	4.30kW	76%	E
563-258	Midi Midline	Balanced	Nat.Gas	4.80kW	3.90kW	90.6%	B#
563-790	Midi Midline	Balanced	LPG	4.80kW	4.00kW	90.6%	B#
663-806	Midi Electric	-	Electric	-	1.50kW	-	-
663-834	Midi Midline Electric	-	Electric	-	1.50kW	-	-

Vogue Midi T Gas & Electric (3 Sided)

563-180	Midi T, 3 Sided	Conventional	Nat.Gas	6.20kW	4.40kW	78%	E
563-701	Midi T, 3 Sided	Conventional	LPG	5.90kW	4.20kW	78%	E
563-025	Midi T, 3 Sided	Balanced	Nat.Gas	5.70kW	4.80kW	94.3%	A#
563-749	Midi T, 3 Sided	Balanced	LPG	5.00kW	4.30kW	94.3%	A#
563-224	Midi T Midline, 3 Sided	Conventional	Nat.Gas	6.20kW	4.40kW	78%	E
563-493	Midi T Midline, 3 Sided	Conventional	LPG	5.90kW	4.20kW	78%	E
563-300	Midi T Midline, 3 Sided	Balanced	Nat.Gas	5.70kW	4.80kW	94.3%	A#
563-676	Midi T Midline, 3 Sided	Balanced	LPG	5.00kW	4.30kW	94.3%	A#
563-216**	Midi T Highline, 3 Sided	Balanced	Nat.Gas	5.70kW	4.80kW	94.3%	A#
563-458**	Midi T Highline, 3 Sided	Balanced	LPG	5.00kW	4.30kW	94.3%	A#
563-013	Midi T, 3 Sided, Wall Mounted	Balanced	Nat.Gas	5.70kW	4.80kW	94.3%	A#
563-506	Midi T, 3 Sided, Wall Mounted	Balanced	LPG	5.00kW	4.30kW	94.3%	A#
663-819	Midi T Electric, 3 Sided	-	Electric	-	1.50kW	-	-
663-851	Midi T Midline Electric, 3 Sided	-	Electric	-	1.50kW	-	-
663-896**	Midi T Highline Electric, 3 Sided	-	Electric	-	1.50kW	-	-
663-860	Midi T Electric, Wall Mounted, 3 Sided	-	Electric	-	1.50kW	-	-

When upgraded with a Programmable Thermostatic Control (8456)

Stove Flue Pipe

	Product Code
1' Straight pipe, Matt Black	4500
2' Straight pipe, Matt Black	4501
3' Straight pipe, Matt Black	4502
90° long 'elbow' adaptor (9" projection), Matt Black	4514

Stove Flue Pipe Balanced flue versions of the Gas Vogue Midi and Midi T must only use the 6" stainless steel flue provided. Gazco recommends the use of 5" matt black enamelled stove pipe with the conventional flue version of the Gas Vogue Midi and Midi T.

** Whilst Stocks Last

Technical Information

The below information is to assist in your choice of a suitable Gazco stove. This is not intended to be all the information required to install your stove. This can be obtained from your local Gazco retailer or you can download the full installation instructions at www.gazco.com

Vision Gas and Electric

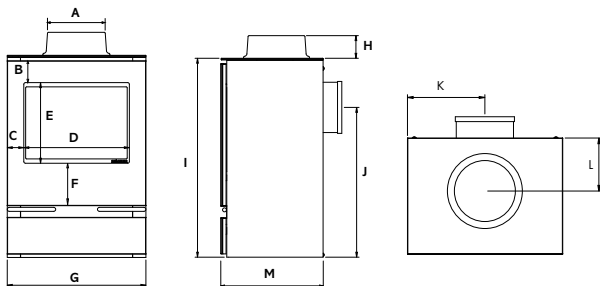

Recommended clearances between stove and other surfaces: top 225mm, sides 150mm and rear 50mm.

Stove Benches Vision stoves can also be placed on one of our stove benches. Please see page 78 for further information.

* Small balanced flue models are rear flue exit only

Dimensions (mm)

	A	B	C	D	E	F	G	H	I	J	K	L	M	Weight
Small Gas (CF)	143	57	58	254	240	122	370	43	529	359	185	97	289	33kg
Small Gas (BF)*	-	57	58	254	240	122	370	-	529	379	185	-	289	33kg
Midi Gas (CF)	143	65	50	316	241	127	415	43	605	436	208	96	311	39kg
Midi Gas (BF)	173	65	50	316	241	127	415	69	605	456	208	142	311	41kg
Medium Gas (CF)	143	77	64	408	274	150	535	43	677	487	268	100	353	45kg
Medium Gas (BF)	173	77	64	408	274	150	535	69	677	538	268	139	353	55kg
Small Electric	-	57	58	254	240	122	370	-	555	-	-	-	299	24kg
Midi Electric	-	65	50	316	241	127	415	-	604	-	-	-	320	28kg
Medium Electric	-	77	64	408	274	152	535	-	676	-	-	-	363	38kg

Remote Controls

	Product Code
Standard Upgradeable Remote Control	8455
Programmable Thermostatic Upgradeable Remote Control	8456

Stove Flue Pipe

1' Straight pipe, Matt Black	4500
2' Straight pipe, Matt Black	4501
3' Straight pipe, Matt Black	4502
90° long 'elbow' adaptor (9" projection), Matt Black	4514

Stove Flue Pipe Balanced flue versions of the Gas Visions must only use the 6" stainless steel or anthracite flue pipe. For the conventional flue version of the Gas Vision Gazco recommends the use of 5" matt black or gloss enamelled stove pipe.

Product Code	Model	Flue Type	Fuel Type	Flue Exit	Heat Input (kW)	Heat Output (kW)	Efficiency	Energy Efficiency Class
⊗ 526-013	Small	Conventional	Nat. Gas	Rear	3.30	2.30	76%	E
⊗ 526-643	Small	Conventional	LPG	Rear	3.20	2.20	76%	E
⊗ 526-021	Small	Conventional	Nat Gas	Top	3.30	2.30	76%	E
⊗ 526-656	Small	Conventional	LPG	Top	3.20	2.20	76%	E
⊗ 526-046	Small	Balanced	Nat. Gas	Rear	3.20	2.50	85.1%	C#
⊗ 526-405	Small	Balanced	LPG	Rear	3.10	2.40	85.1%	C#

Gas Vision Midi

⊗ 526-065	Midi	Conventional	Nat.Gas	Rear	4.55	3.10	75%	E
⊗ 526-417	Midi	Conventional	LPG	Rear	4.35	3.00	75%	E
⊗ 526-077	Midi	Conventional	Nat.Gas	Top	4.55	3.10	75%	E
⊗ 526-440	Midi	Conventional	LPG	Top	4.35	3.00	75%	E
⊗ 526-100	Midi	Balanced	Nat. Gas	Rear	4.30	3.70	95.4%	A#
⊗ 526-471	Midi	Balanced	LPG	Rear	4.30	3.80	95.4%	A#
⊗ 526-109	Midi	Balanced	Nat. Gas	Top	4.30	3.70	95.4%	A#
⊗ 526-486	Midi	Balanced	LPG	Top	4.30	3.80	95.4%	A#

Gas Vision Medium

⊗ 526-122	Medium	Conventional	Nat.Gas	Rear	6.60	4.60	78%	E
⊗ 526-515	Medium	Conventional	LPG	Rear	6.70	4.80	78%	E
⊗ 526-137	Medium	Conventional	Nat.Gas	Top	6.60	4.60	78%	E
⊗ 526-539	Medium	Conventional	LPG	Top	6.70	4.80	78%	E
⊗ 526-155	Medium	Balanced	Nat. Gas	Rear	6.60	5.40	90.8%	B#
⊗ 526-580	Medium	Balanced	LPG	Rear	6.60	5.50	90.8%	B#
⊗ 526-176	Medium	Balanced	Nat Gas	Top	6.60	5.40	90.8%	B#
⊗ 526-612	Medium	Balanced	LPG	Top	6.60	5.50	90.8%	B#

Electric Vision

⊗ 634-808	Small	-	Electric	-	-	2.00	-	-
⊗ 634-846	Midi	-	Electric	-	-	2.00	-	-
⊗ 634-889	Medium	-	Electric	-	-	2.00	-	-

When upgraded with a Programmable Thermostatic Control (8456)

Technical Information

The below information is to assist in your choice of a suitable Gazco stove. This is not intended to be all the information required to install your stove. This can be obtained from your local Gazco retailer or you can download the full installation instructions at www.gazco.com

Loft Gas

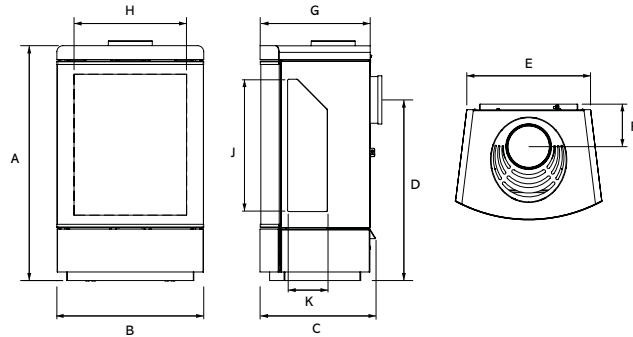

Recommended clearances between stove and other surfaces: top 225mm, sides 200mm, rear must be a minimum of 50mm.

Dimensions (mm)

	A	B	C	D	E	F	G	H	J	K
Loft	770	481	379	CF:600 / BF:592	406	CF:139 / BF:137	359	369	434	130
Loft with Plinth	815	481	379	CF:646 / BF:638	406	CF:139 / BF:137	359	369	434	130
Loft with Top Section	1412	481	379	CF:600 / BF:592	406	CF:139 / BF:137	359	369	434	130
Loft with Plinth & Top Section	1457	481	379	CF:646 / BF:638	406	CF:139 / BF:137	359	369	434	130
Loft with Log Store	1152	481	379	CF:982 / BF:974	406	CF:139 / BF:137	359	369	434	130
Loft with Log Store & Top Section	1793	481	379	CF:982 / BF:974	406	CF:139 / BF:137	359	369	434	130
Loft Wall Mounted	770	481	399	BF:592	406	BF:137	359	369	434	130
Loft Wall Mounted & Top Section	1412	480	399	BF:592	406	BF:137	359	369	434	130

Product Code	Flue Type	Fuel Type	Heat Input	Heat Output	Efficiency	Energy Efficiency Class	Weight
⊗ 548-006	Conventional	Nat.Gas	6.20kW	4.40kW	78%	D	56kg
⊗ 548-443	Conventional	LPG	5.90kW	4.20kW	78%	D	56kg
⊗ 548-032	Balanced	Nat.Gas	5.30kW	4.50kW	94.3%	A	60kg
⊗ 548-457	Balanced	LPG	4.80kW	4.20kW	94.3%	A	60kg

Styling Options

948-191	Loft - Wall Mounting Kit
948-016	Loft Plinth - Steel Graphite
948-030	Loft Log Store - Steel Graphite
948-041	Loft Top Section - Steel Graphite
948-077	Loft Plinth - Woodgrain Sandstone
948-102	Loft Plinth - Castillo Sandstone
948-083	Loft Log Store - Woodgrain Sandstone
948-110	Loft Log Store - Castillo Sandstone

Stove Benches Loft stoves can also be placed on one of our stove benches. Please see page 78 for further information.

Accessories

999-620	Remote System Mains Adaptor
8736	Linerless Flue Kit

Stove Flue Pipe

4500	1' Straight pipe
4501	2' Straight pipe
4502	3' Straight pipe
4514	90° Long 'elbow' adaptor (9" projection)

Stove Flue Pipe Balanced flue versions of the Loft must only use the 6" stainless steel flue provided. Gazco recommends the use of 5" matt black enamelled stove pipe with the conventional flue version of the Loft.



Loft with Steel Log Store Base

Technical Information

The below information is to assist in your choice of a suitable Gazco stove. This is not intended to be all the information required to install your stove. This can be obtained from your local Gazco retailer or you can download the full installation instructions at www.gazco.com

CL3, CL5 & CL8 Gas and Electric

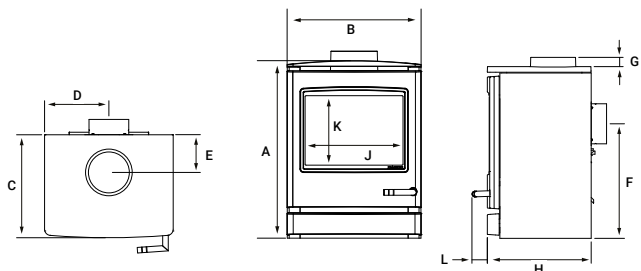

Recommended clearances between stove and other surfaces: top 225mm, sides 150mm rear must be a minimum of 50mm.

The complete range of CL stoves have a choice of top or rear flue exit.[^]

Stove Benches CL stoves can also be placed on one of our stove benches. Please see page 78 for further information.

CL3, CL5 & CL8 Gas & Electric Dimensions (mm)

	A	B	C	D	E	F	G	H	J	K	L	Weight
CL3 Gas (CF)	541	371	313	185.5	99	359	30	313	252	243	49	42kg
CL3 Gas (BF)[^]	541	371	313	185.5	99	379	30	313	252	243	49	42kg
CL5 Gas(CF)	551	416	333	208	122	368	30	333	314	244	49	47kg
CL5 Gas (BF)	551	416	333	208	142	388	35	333	314	244	49	47kg
CL8 Gas (CF)	604	553	365	277	99	411	20	364	427	274	48	50kg
CL8 Gas (BF)	604	553	365	277	129	462	51	364	427	274	48	60kg
CL3 Electric	541	371	313	-	-	-	-	-	252	244	-	40kg
CL3 Electric	552	416	333	-	-	-	-	-	311	244	-	44kg
CL5 Electric	604	553	374	-	-	-	-	-	247	274	-	47kg

[^] Small balanced flue models are rear flue exit only

Options for CL Gas stoves

	Product Code
Standard Upgradeable Remote Control	8455
Programmable Thermostatic Upgradeable Remote Control	8456

Product Code	Model	Colour	Flue Type	Fuel Type	Fuel Exit	Heat Input	Heat Output	Efficiency	Energy Efficiency Class
⊗ YM581-003	CL3	Matt Black	Conventional	Nat. Gas	Rear	3.30kW	2.30kW	76%	E
⊗ YM581-409	CL3	Matt Black	Conventional	LPG	Rear	3.20kW	2.20kW	76%	E
⊗ YM581-016	CL3	Matt Black	Conventional	Nat. Gas	Top	3.30kW	2.30kW	76%	E
⊗ YM581-427	CL3	Matt Black	Conventional	LPG	Top	3.20kW	2.20kW	76%	E
⊗ YM581-038	CL3	Matt Black	Balanced	Nat. Gas	Rear	3.20kW	2.50kW	85.10%	C*
⊗ YM581-443	CL3	Matt Black	Balanced	LPG	Rear	3.10kW	2.40kW	85.10%	C*
⊗ YM581-059	CL5	Matt Black	Conventional	Nat. Gas	Rear	4.55kW	3.10kW	75%	E
⊗ YM581-460	CL5	Matt Black	Conventional	LPG	Rear	4.35kW	3.00kW	75%	E
⊗ YM581-090	CL5	Matt Black	Conventional	Nat. Gas	Top	4.55kW	3.10kW	75%	E
⊗ YM581-484	CL5	Matt Black	Conventional	LPG	Top	4.35kW	3.00kW	75%	E
⊗ YM581-100	CL5	Matt Black	Balanced	Nat. Gas	Rear	4.30kW	3.70kW	95.40%	A*
⊗ YM581-503	CL5	Matt Black	Balanced	LPG	Rear	4.30kW	3.80kW	95.40%	A*
⊗ YM581-114	CL5	Matt Black	Balanced	Nat. Gas	Top	4.30kW	3.70kW	95.40%	A*
⊗ YM581-536	CL5	Matt Black	Balanced	LPG	Top	4.30kW	3.80kW	95.40%	A*
⊗ YM581-126	CL8	Matt Black	Conventional	Nat. Gas	Rear	6.60kW	4.60kW	78.0%	E
⊗ YM581-567	CL8	Matt Black	Conventional	LPG	Rear	6.70kW	4.80kW	78.0%	E
⊗ YM581-141	CL8	Matt Black	Conventional	Nat. Gas	Top	6.60kW	4.60kW	78.0%	E
⊗ YM581-588	CL8	Matt Black	Conventional	LPG	Top	6.70kW	4.80kW	78.0%	E
⊗ YM581-174	CL8	Matt Black	Balanced	Nat. Gas	Rear	6.80kW	5.40kW	90.8%	B*
⊗ YM581-601	CL8	Matt Black	Balanced	LPG	Rear	6.80kW	5.40kW	90.8%	B*
⊗ YM581-207	CL8	Matt Black	Balanced	Nat. Gas	Top	6.80kW	5.40kW	90.8%	B*
⊗ YM581-654	CL8	Matt Black	Balanced	LPG	Top	6.80kW	5.50kW	90.8%	B*
⊗ YM681-196	CL3	Matt Black	-	Electric	-	-	2.00kW	-	-
⊗ YM681-331	CL5	Matt Black	-	Electric	-	-	2.00kW	-	-
⊗ YM681-374	CL8	Matt Black	-	Electric	-	-	2.00kW	-	-

* When upgraded with a Programmable Thermostatic Control (8456)

Technical Information

The below information is to assist in your choice of a suitable Gazco stove. This is not intended to be all the information required to install your stove. This can be obtained from your local Gazco retailer or you can download the full installation instructions at www.gazco.com



Liberty 85 Electric in White with matching White Bench, with Crystal-ice fuel effect and Blue flame setting

Liberty 85 Electric

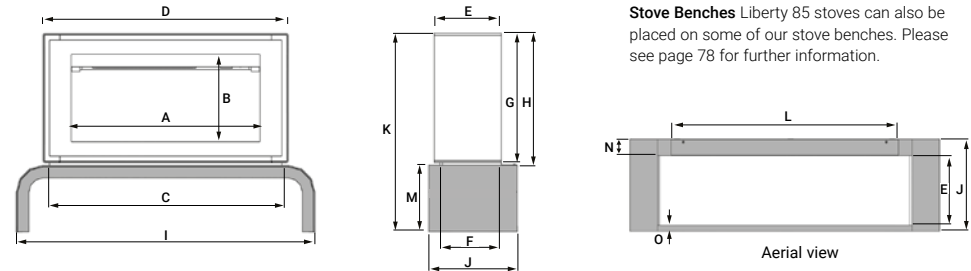

Liberty 85 Electric Dimensions (mm)

	A	B	C	D	E	F	G	H	I	J	K	L	M	N	O
Liberty 85 on Bench	855	396	1050	1110	300	275	584	596	1350	396	896	991	300	71	27
Liberty 85 on Plinth	855	396	1050	1110	300	275	584	596	1305	585	649	991	53	71	114
Liberty 85 (without Plinth or Bench)	855	396	1050	1110	300	275	584	596	-	-	-	-	-	-	-

Product Code	Model	Colour	Fuel Type	Heat Output (kW)
⊗ 610-107	Liberty 85 - Black	Black (front)	Electric	2.00
⊗ 610-126	Liberty 85 - White	White (front)	Electric	2.00

Plinth & Bench Mounting Choice

999-048	Liberty 85 Plinth - Black
999-087	Liberty 85 Plinth - White
999-127	Liberty 85 Bench - Black
999-166	Liberty 85 Bench - White



Liberty 85 Electric in Black with Log & Pebble fuel effect and Amber flame setting

Technical Information

The below information is to assist in your choice of a suitable Gazco stove. This is not intended to be all the information required to install your stove. This can be obtained from your local Gazco retailer or you can download the full installation instructions at www.gazco.com



Studio 1 Freestanding with matching Black Plinth and EchoFlame Black Glass Lining

Studio Freestanding 1 Gas

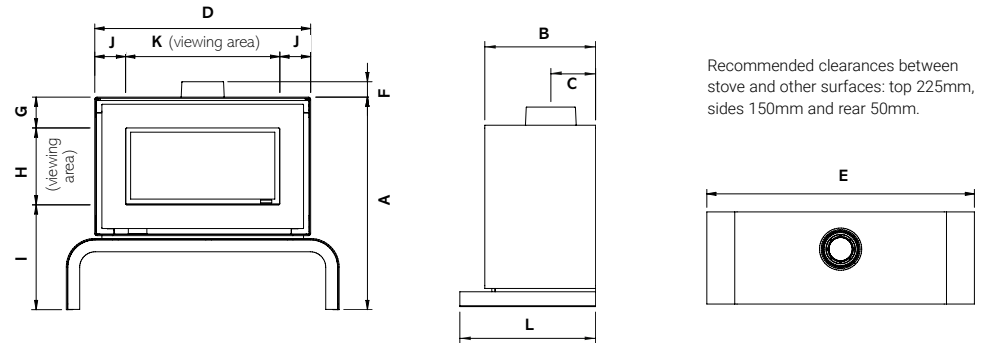

Dimensions (mm)

	A	B	C	D	E	F	G	H	I	J	K	L	Weight
Studio 1 Freestanding on Bench	896	396	CF: 148 BF: 160	910	1150	CF: 43 BF: 65	130	324	442	130	650	-	146kg
Studio 1 Freestanding on Plinth	649	396	CF: 148 BF: 160	910	1105	CF: 43 BF: 65	130	324	195	130	650	485	141.5kg

Product Code	Finish	Flue Type	Fuel Effect	Lining	Fuel Type	Heat Input (kW)	Heat Output (kW)	Efficiency	Energy Efficiency Class
Studio 1 Freestanding									
☒ 508-147	Black	Conventional	Logs	Black Glass	Nat. Gas	6.30	4.10	72%	E
☒ 508-589	Black	Conventional	Logs	Black Glass	LPG	6.90	4.60	72%	E
☒ 508-248	Black	Balanced	Logs	Black Glass	Nat. Gas	6.30	5.20	92%	A
☒ 508-597	Black	Balanced	Logs	Black Glass	LPG	6.30	5.30	92%	A

Plinth & Bench Mounting Choice (Required)

999-022	Studio 1 Freestanding Plinth - Black
999-035*	Studio 1 Freestanding Plinth - White
999-101	Studio 1 Freestanding Bench - Black
999-114*	Studio 1 Freestanding Bench - White

Additional Lining Sets

923-010	Studio 1 CF - Vermiculite Lining Set
923-517	Studio 1 CF - Black Reeded Lining Set
923-433	Studio 1 BF - Vermiculite Lining Set
923-607	Studio 1 BF - Black Reeded Lining Set

Accessories

999-620	Remote System Mains Adaptor
---------	-----------------------------

*Whilst Stocks Last

Technical Information

The below information is to assist in your choice of a suitable Gazco stove. This is not intended to be all the information required to install your stove. This can be obtained from your local Gazco retailer or you can download the full installation instructions at www.gazco.com

Studio Freestanding 2 Gas

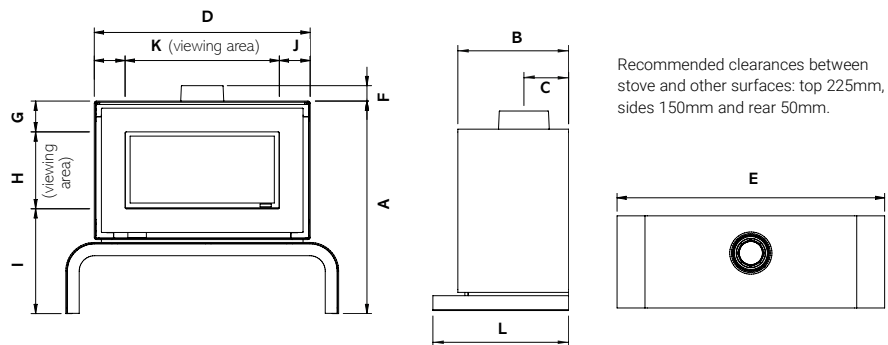

Dimensions (mm)	A	B	C	D	E	F	G	H	I	J	K	L	Weight
Studio 2 Freestanding on Bench	896	396	CF: 148 BF: 160	1110	1350	CF: 43 BF: 65	130	324	442	130	850	-	148kg
Studio 2 Freestanding on Plinth	649	396	CF: 148 BF: 160	1110	1305	CF: 43 BF: 65	130	324	195	130	850	485	143.5kg

Product Code	Finish	Flue Type	Fuel Effect	Lining	Fuel Type	Heat Input (kW)	Heat Output (kW)	Efficiency	Energy Efficiency Class
508-094	Black	Conventional	Logs	Black Glass	Nat. Gas	8.50	6.20	81%	C
508-426	Black	Conventional	Logs	Black Glass	LPG	8.40	6.30	82%	C
508-027	Black	Balanced	Logs	Black Glass	Nat. Gas	8.50	7.00	92%	A
508-444	Black	Balanced	Logs	Black Glass	LPG	8.00	6.80	92%	A

Studio 2 Freestanding

Plinth & Bench Mounting Choice (Required)

999-048	Studio 2 Freestanding Plinth - Black
999-087	Studio 2 Freestanding Plinth - White
999-127	Studio 2 Freestanding Bench - Black
999-166	Studio 2 Freestanding Bench - White

Additional Lining Sets

923-337	Studio 2 CF - Vermiculite Lining Set
923-744	Studio 2 CF - Black Reeded Lining Set
923-938	Studio 2 BF - Vermiculite Lining Set
923-476	Studio 2 BF - Black Reeded Lining Set

Accessories

999-620	Remote System Mains Adaptor
---------	-----------------------------



Studio 2 Freestanding with matching Black Bench and Black Reeded lining

Balanced Flue Gas Stove Systems

The Gazco Balanced Flue system means no chimney is not a problem if you opt for a balanced flue gas stove, as it draws combustion air from outside through its concentric pipe systems. A full range of optional flue components is available to suit configurations shown on page 80.

Gazco have specifically developed a range of flue system components to complement your balanced flue stove. Crafted from 304 grade stainless steel and aluminium with some items additionally offered in anthracite and matt ivory paint finishes. Designed with ease of installation and flexibility in mind, these flue systems simply push together without the requirement for locking bands or screws. Both the inner and outer pipes are secured with easy fit, self locking, high temperature silicone seals. For further information, please speak to your retailer or visit www.gazco.com.

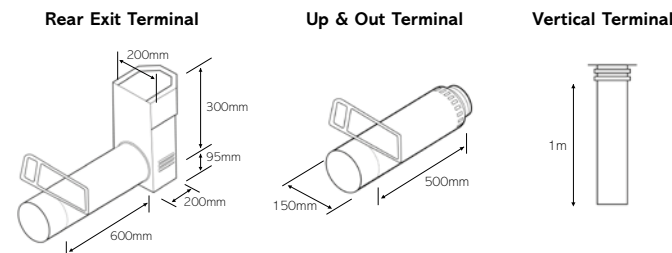

Components for Balanced Flue Models

Basic Stainless Steel Kits	Product Code
Rear exit, horizontal - complete with terminal guard	8526
Top exit, up & out for Chesterfield 5, Sheraton 5, Huntingdon 30, Stockton 5, Loft, Vision Midi & all Vogues	8523
Top exit, up & out for Vision Medium	8509
Top exit, vertical for all Loft & Vogue Midi T	8524
Top exit vertical for Chesterfield 5, Sheraton 5, Huntingdon 30/40, Stockton 5, Vision & Vogue Midi	999-539
45° offset bend (set of two) for use with 8524	8530
Basic Anthracite Steel Kits*	
Top exit, up & out for Chesterfield 5, Sheraton 5, Huntingdon 30, Stockton 5, Loft, Vision Midi & all Vogues	8523AN
Top exit, up & out for Vision Medium	8509AN
Top exit, vertical for all Loft & Vogue Midi T	8524AN
Top exit vertical for Chesterfield 5, Sheraton 5, Huntingdon 30/40, Stockton 5, Vision & Vogue Midi	999-539AN
45° offset bend (set of two) for use with 8524AN	8530AN
Basic Matt Ivory Steel Kits*	
Top exit, up & out for Huntingdon 30	999-111
Top exit vertical for Huntingdon 30/40	999-224
Additional Anthracite Steel components for top exit (as required)	
200mm straight (effective length 140mm)	8527AN
500mm straight (effective length 440mm)	8528AN
1000mm straight (effective length 940mm)	8529AN
15° bend	999-031
30° bend	999-078
45° bend	8507AN
90° bend	8508AN

Additional Stainless Steel components for top exit (as required)	Product Code
200mm straight (effective length 140mm)	8527
500mm straight (effective length 440mm)	8528
1000mm straight (effective length 940mm)	8529
364-554mm adjustable straight	999-062
15° bend	999-003
30° bend	999-016
45° bend	8507
90° bend	8508
Horizontal flue terminal (wall)	999-105
Vertical flue terminal (roof)	999-141
Fixed wall support	999-072
Adjustable wall support	999-130
External wall finishing plate	999-235

Additional Matt Ivory Steel components for top exit (as required)	Product Code
200mm straight (effective length 140mm)	999-357
500mm straight (effective length 440mm)	999-372
1000mm straight (effective length 940mm)	999-391
15° bend	999-051
30° bend	999-067
45° bend	999-172
90° bend	999-284

Terminal Guards	Product Code
Rear exit	999-159
Horizontal exit	999-201

*Note: Terminal lengths are stainless steel.

Please note the Small Balanced Flue models of Marlborough2, Stockton2, Huntingdon 20 and Vision Small are rear flue exit only.

The above information is to assist in your choice of a suitable Gazco stove. This is not intended to be all the information required to install your stove. This can be obtained from your local Gazco retailer or you can download the full installation instructions from the Gazco website at www.gazco.com.

Aquaseal Flashings	Product Code
125-175mm Aluminium Base EPDM Black to 115°C	FXQ-052
150-300mm Aluminium Base EPDM Black to 115°C	FXQ-053
150-200mm Lead Base EPDM Black to 115°C	FXQ-054
150-250mm Sq Section EPDM Black to 115°C	FXQ-058
150-250mm Sq Section/Metal EPDM Black to 115°C	FXQ-059
EPDM Flashing Fixing Kit	FXQ-059SK

Lead Flashings	Product Code
Flat Lead Flashing	999-154
30-40 Degree Lead Flashing	999-161
40-50 Degree Lead Flashing	999-174
45-50 Degree Lead Flashing	999-182
45-50 Degree Ridge Flashing	999-193

Additional Components	Product Code
Roof Support Balanced Flue	999-032
Fire Stop Balanced Flue	999-040
Storm Collar Balanced Flue	999-046R
Rear Heat Shield Plate Kit to be used with 8526 , if required	999-220

Additional Cast Iron Components for Top Exit	Product Code
Flue collar (BF), Matt Black	8548
Flue collar (BF), Matt Black - Huntingdon 30 & 40 only	999-347
Flue collar (BF), Matt Ivory - Huntingdon 30 & 40 only	999-507
Flue collar (BF), Ivory Enamel - Huntingdon 30 & 40 only	999-683

Also Available from the Stovax Heating Group

Stovax Wood & Multi-fuel Stoves

Stovax, our solid fuel division, offer a huge range of beautiful stoves that burn wood and other solid fuels. Designed and engineered here in the UK, these appliances offer a natural and practical home heating solution.

Choose from a stunning range of modern and traditional styles in various sizes and heat outputs to suit your home. For more details speak with your local retailer or visit www.stovax.com.



Stovax Sheraton 5 woodburning stove shown with Cavendish Bolection Limestone mantel



Gazco eReflex 150RW with Oak Log effect, shown as a three-sided installation. Shown with optional Mood Lighting System.

Gazco Gas & Electric Fires

In addition to the wide selection of stoves shown in this brochure, Gazco also offers a number of gas and electric fires, which are covered in a separate dedicated brochures. Whether you want to achieve a contemporary look or traditional interior, Gazco has the perfect solution whatever your style or budget.

Ask your local retailer for more information or download the brochure from www.gazco.com.



Gazco Reflex 75T 3-Sided Gas fire

onyx

Luxury Fires and Stoves

In addition to the Gazco brand, the Stovax Heating Group is proud to offer a new and growing premium collection of fires and stoves from luxury brand, Onyx.

This showroom exclusive brand is available from a carefully selected group of Approved Onyx Retailers, and includes the Onyx Liv 3 gas stove. Offering a fully integrated control system, 180° views, and ultra-realistic flames, the Liv 3's elegant, curved design makes for the ultimate contemporary centrepiece to add poise and allure in the home.

To find out more about the Onyx brand and experience, visit www.onyxfires.com.



View the Video
onyxfires.com/liv3



Gas Huntingdon 30 with Tracery Door in Ivory Enamel.
Shown with Claremont Limestone Mantel



Vogue Midi T Midline Electric with Log & Pebble Fuel effects and Amber flame setting



Gazco Limited, Osprey Road, Sowton Industrial Estate, Exeter, Devon, England EX2 7JG

Trade Sales

Tel: 01392 261999 • NI: 01392 261990

Email: info@gazco.com • NI: northernireland@gazco.com

Export Sales

Tel: +44 1392 261990

Email: exportsales@gazco.com



gazco.com



Gazco gratefully acknowledges the assistance of the following companies with photographic settings:

www.furniturevillage.co.uk; www.romo.com; www.debenhams.com; www.theorangerie.co.uk; www.justshutters.co.uk; www.homebase.co.uk; www.lauraashley.com; www.loaf.com; www.nestinteriors.com; www.graceandgloryhome.co.uk; www.stbridgetnurseryseries.co.uk; www.johnlewis.com; www.wayfair.com; www.veryvintagehire.co.uk; www.carpetright.co.uk; www.beachbros.co.uk; www.birlea.com; www.originalstyle.com; www.amtico.com; www.chunkymonkeyfurniture.co.uk; www.wallsandfloors.co.uk; www.desenio.co.uk; www.ikea.com;

Paper sourced from sustainable forests and printed using vegetable based inks • © All material copyright Gazco Ltd 2021 E & O E • A member of the Stovax group

Gazco pursue a policy of continuous product improvement, therefore, whilst our products are correct at the time of the photography, we reserve the right to make alterations and amendments. Exact product details should be discussed with your retailer at the time of purchase.

Find Your Local Expert Retailer

You can find your nearest retailer by visiting:
www.gazco.com/retailers



Your Gazco stockist:

Ref: STOV1221

